



GD4 Glass Right

Installation Guide

Operating Instructions

Warranty

GD4 GR Installation Guide, Operating Instructions & Warranty

IMPORTANT!

This gas appliance must be installed to **AS/NZS 5601.1:2013** by a qualified person and in accordance with these instructions. Failure to install the appliance correctly will void your warranty and may cause a fire. This appliance should not be modified under any circumstances.

Under no circumstances should any combustibles such as paper, wood or coal be used in this appliance.

It is recommended that you have this appliance serviced annually by a qualified technician.

Warranty repairs must be carried out by a 'The Fire Dept.' authorised technician.

This appliance must ALWAYS terminate/flue outdoors.

Young children, elderly or infirm should be supervised to ensure that they are careful with the appliance.

Clothing and other flammable materials should never be placed near the appliance.

Never switch the appliance on without the glass in place.

Please note that parts (near the flame) of this appliance, particularly the steel surrounding, glass panels to the face or the door, become extremely hot during operation and can result in serious injury and burns if touched. It is therefore recommended that a fireguard complying with BS 8423:2002 is used in the presence of young children, the elderly or infirm.

The GD4 GR installation process consists of 8 steps	Page
Step 1: Ensure all components are correct and undamaged.	3
Step 2: Install plinth (if required).	3
Step 3: Install appliance into cavity	3
Glass removal process	4
Glass installation process	5
Burner tray removal process	6
Burner tray installation process	7
Step 4: Install flue and connect to appliance	9
Step 5: Connect and test electrical supply	13
Step 6: Connect gas supply and commission	15
Step 7: Lay the firebed	16
How to lay River Rocks firebed	19
How to lay Beach Driftwood firebed	21
How to lay Forest Logs firebed	23
Step 8: Show owner how to operate appliance	25
Operating Instructions.	26
Troubleshooting	26
Warranty	27

Information in this installation guide may be subject to change without notice. Please ensure that you have the current version before beginning installation.

If you have any queries, please contact 'The Fire Dept.' on 0800 888 550

Step 1: Unpack and ensure all components are correct and undamaged

- Appliance
- Box of firebed mediums
- Flue kit

Step 2: Install plinth (if required)

- If the appliance is to sit on a plinth, ensure it is capable of supporting a 200kg load.
- There is no clearance requirement for the base of the appliance. It may safely sit directly upon combustible (eg. timber) and non-combustible (eg. concrete) materials.

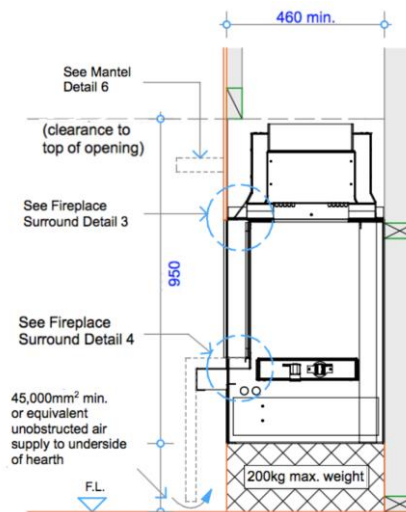

Step 3: Install appliance into cavity

- Before installation, confirm all minimum clearances from the outside surfaces of the fire to the surrounding enclosure are no closer than 25mm from combustible materials and 5mm from non-combustible materials.
- The exception to these minimum clearances is the base and the outer 2mm steel perimeter panels of the fire, the base can safely sit directly upon combustible (eg. timber) and non-combustible (eg. concrete) materials. The outer 2mm steel perimeter panels and rear air channel can safely touch combustible (eg. timber) and non-combustible (eg. concrete) materials.

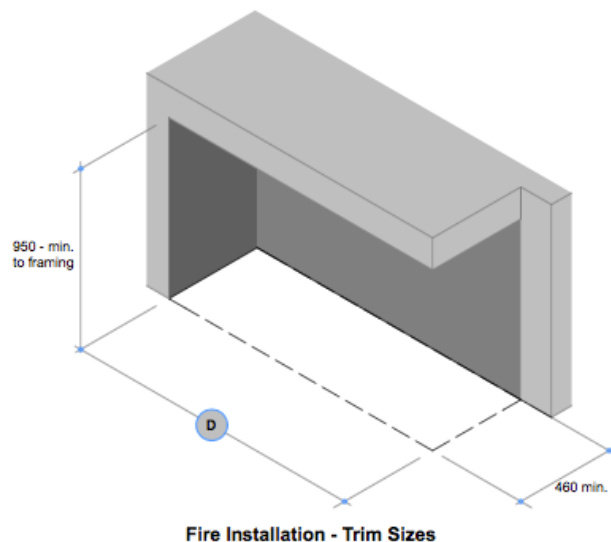

- If a gas supply pipe has already been run to the cavity, ensure 1000mm of 3/8 soft copper tube is available at the lower side of the cavity, as this is where the copper tube with the gas supply enters the appliance.
- If an electrical supply cable has already been run to the cavity (must be a minimum of 1.0mm 5 core cable), ensure that the cable reaches the lower side of the cavity, as this is where it will enter the fire.
- In order to access the fixing slots in the base of the fire, and the gas and electrical connections, it is necessary to first remove the glass and the burner tray.

Glass removal process

- **Note:** Glass removal is best carried out by two people.
- Carefully remove glass, which is held in place by retaining clips along the top of the glass and powerful magnets in each lower corner.
- Remove the top retaining clips by undoing the 4mm Allen head cap screws.



- Gently pull at the top corners in a forward motion. The glass will tilt forward.



- In one movement gently pull the glass up and away from the fire to break the magnetic connection. Take care that the glass doesn't fall completely off once it's free from the fixing magnets.
- Lift glass away from fire and lay flat in a safe place with insulating material facing down to protect glass

Glass installation process

- **Note:** Glass installation is best carried out by two people. Check all glass edges and surfaces for damage. Do not install the glass if it is damaged. Check that the insulating material (ladder rope around the outer edge of the glass and around the opening of the fire) is complete and undamaged. Do not install the glass if the insulating material is damaged or missing.
- The glass face that forms the 90° butt joint should not include the black edge banding or ladder rope. The 90° butt joint should have a 5mm minimum gap between the two glass panels.

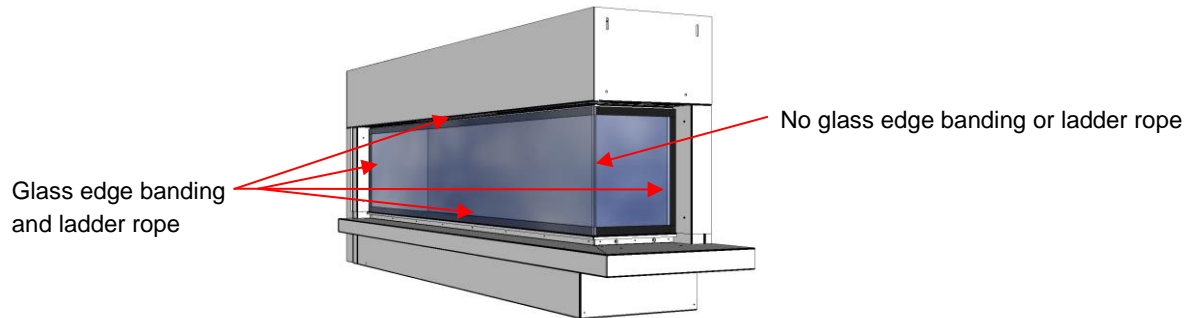

- Carefully install the glass, which is held in place by retaining clips along the top of the glass and powerful magnets in each lower corner.

- On the back corner of each glass there are 3mm steel magnet panels. In one Movement, gently lower the glass down allowing the steel magnet panels to catch the top front face of the magnets. Take care lowering the glass completely down into position. The glass will lower onto a 3mm safety switch pin. There is a safety switch at the base of each glass panel.

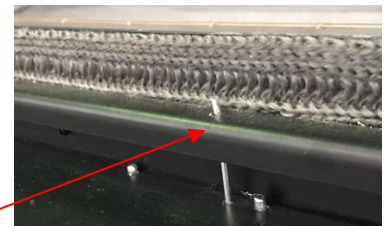

Safety switch pin



- Gently push the top corners of the glass back into position.





- Tighten the 4mm cap screws that hold the glass retaining clips in position. Make sure the retaining clips sit flat onto the glass surface.





Burner Tray Removal Process

	Cover and end cap removal	
<p>GD4 GR Pilot cover</p> <p>This model has one pilot cover.</p>	<ul style="list-style-type: none"> Remove the stainless steel pilot cover (2 x screws) at the pilot end of the burner. 	 <p>Pilot cover</p>
<p>GD4 GR Burner end caps</p> <p>This model has two end cap covers, one at each side of the burner.</p>	<ul style="list-style-type: none"> Remove the stainless steel burner end caps (3 x screws on each cap) at either end of the burner tray. 	 <p>Non pilot burner end Pilot burner end</p>

	LPG	Natural Gas
<p>GD4 GR 1200</p> <p>Input 18-28 MJ/h</p> <p>One gas injector at the pilot side of the burner tray.</p>	<ul style="list-style-type: none"> Remove the burner tray by carefully pushing it away from the pilot and lift the pilot end of the burner tray, lift the burner tray up and away from the pilot in one movement. Stand the burner tray on its end and lean against a stable surface. 	<ul style="list-style-type: none"> Remove the burner tray by carefully pushing it away from the pilot and lift the pilot end of the burner tray, lift the burner tray up and away from the pilot in one movement. Stand the burner tray on its end and lean against a stable surface.
<p>GD4 GR 1400</p> <p>Input 20-28 MJ/h</p> <p>Two gas injectors one at the right and one at left hand sides of the burner tray.</p>	<ul style="list-style-type: none"> Remove the burner tray by carefully pushing it away from the pilot and lift the pilot end of the burner tray, lift the burner tray up and away from the pilot in one movement. Ensure that the gas injector at the left hand side is not damaged as the burner tray is lifted out. Stand the burner tray on its end and lean against a stable surface. 	<ul style="list-style-type: none"> On the pilot side gas injector, loosen and spin back the 12mm brass nut away from the burner tray. <div style="text-align: center;">  <p>Pilot side Gas Injector</p> </div>
<p>GD4 GR 1600</p> <p>Input 30-38 MJ/h</p> <p>Two gas injectors one at the right and one at left</p>	<ul style="list-style-type: none"> Remove the burner tray by carefully pushing it away from the pilot and lift the pilot end of the burner tray, lift the burner tray up and away from the pilot in one movement. Stand the burner tray on its end and lean against a stable surface. 	<ul style="list-style-type: none"> On the non-pilot side injector, loosen both the 12mm brass nuts all the way to the end of the injector. The injector will need to be pushed away from the burner tray. <div style="text-align: center;">  <p>Non-pilot side Gas Injector</p> </div> <ul style="list-style-type: none"> Remove the burner tray by carefully pushing it away from the pilot and lift the pilot end of the burner tray, lift the burner tray up and away from the pilot in one movement. Stand the burner tray on its end and lean against a stable surface.

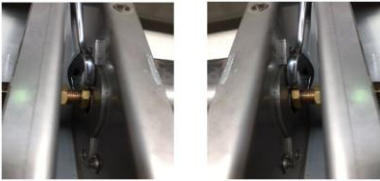
Burner Tray Installation Process

	LPG	Natural Gas
<p>GD4 GR 1200</p> <p>Input 18-26 MJ/h One gas injector at the pilot side of the burner tray.</p>	<ul style="list-style-type: none"> Install the burner tray by carefully lowering the end opposite from the pilot meanwhile holding up the pilot end, lower the burner tray down and move towards the pilot in one movement. Ensure the burner tray is located correctly into the burner bracket and the jets are aiming into the burner tube inlet holes. 	<ul style="list-style-type: none"> Install the burner tray by carefully lowering the end opposite from the pilot meanwhile holding up the pilot end, lower the burner tray down and move towards the pilot in one movement. Ensure the burner tray is located correctly into the burner bracket and the jets are aiming into the burner tube inlet holes. On the pilot side gas injector, gently tighten (do not over tighten) the 12mm brass nut closest to the burner tray.
<p>GD4 GR 1400</p> <p>Input 20-28 MJ/h Two gas injectors one at the right and one at left hand sides of the burner tray.</p>	<ul style="list-style-type: none"> Install the burner tray by carefully lowering the end opposite from the pilot meanwhile holding up the pilot end, lower the burner tray down and move towards the pilot in one movement. Ensure the burner tray is located correctly into the burner bracket and the jets are aiming into the burner tube inlet holes. 	<ul style="list-style-type: none"> Install the burner tray by carefully lowering the end opposite from the pilot meanwhile holding up the pilot end, lower the burner tray down and move towards the pilot in one movement. Ensure the burner tray is located correctly into the burner bracket and the jets are aiming into the burner tube inlet holes. On the non pilot side injector, gently tighten both the 12mm brass nuts. The injector will pull towards the burner tray. On both the non-pilot and pilot side gas injectors, gently tighten (do not over tighten) the 12mm brass nuts closest to the burner tray.
<p>GD4 GR 1600</p> <p>Input 30-38 MJ/h Two gas injectors one at the right and one at left hand sides of the burner tray.</p>		 <p style="text-align: center;">Non-pilot side Gas Injector Pilot side Gas Injector</p>

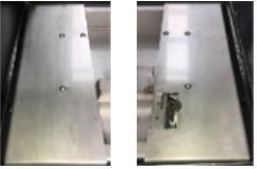
Cover and end cap installation		
<p>GD4 GR Pilot ladder rope</p> <p>This model has ladder rope under the pilot end burner end cap.</p>	<ul style="list-style-type: none"> Ensure the insulating material is glued to the end cap fixing panel and runs behind the 3 way pilot, rectifier and sparker probes. 	 <p style="text-align: center;">Insulating material</p>
<p>GD4 GR Pilot cover</p> <p>This model has one pilot cover.</p>	<ul style="list-style-type: none"> Replace the stainless steel pilot cover (2 x screws) at the pilot end of the burner. 	 <p style="text-align: center;">Pilot cover</p>
<p>GD4 GR Burner end caps</p> <p>This model has two end cap covers, One at each side of the burner</p>	<ul style="list-style-type: none"> Replace the stainless steel burner end caps (3 x screws on each cap) at either end of the burner. 	 <p style="text-align: center;">Non pilot burner end cap Pilot burner end cap</p>

- Slide appliance into position and ensure that it complies with the minimum clearances required (25mm for combustibles, 5mm for non-combustibles) to the firebox inner panels and 5mm surrounding enclosure. The exception to these minimum clearances is the base and the outer 2mm steel perimeter panels of the fire, the base can safely sit directly upon combustible (eg. timber) and non-combustible (eg. concrete) materials. The outer 2mm steel perimeter panels and rear air channel can safely touch combustible (eg. timber) and non-combustible (eg. concrete) materials.
- In order to provide maximum positioning flexibility, the base has four 30mm long slots.
- Mark out and drill fixing holes through the 30mm slots in the base. Ensure holes are drilled in the centre of the slots to allow maximum positioning flexibility. Clear out any debris from drilling,
- Ensure the appliance is level and pack up corners to suit where necessary. Fix bolts / screws into floor. Check and ensure unit is level.

- Once the appliance is level. Fix bolts / screws into framing at the top of the cavity. Check the unit is level and ensure the framing is capable of supporting a 150kg load. The top gather section of the appliance must not be under any torsional stress.

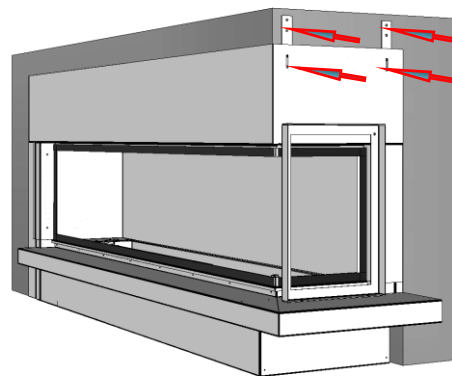

- Once the top section of the appliance is securely fixed to the top of the cavity framing, The supporting frame can be removed and discarded. Ensure the top section of the fire remains level. The top section of the appliance can be adjusted to suit (if required) by repositioning the end brackets.

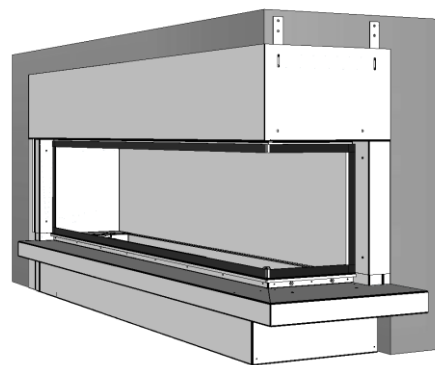

- If the electrician and/or gas fitter is available at this stage the electrical supply and gas supply can be connected and tested/commissioned (see steps 5 & 6).
- Replace the burner tray. The burner tray installation process depends upon the model and type of gas to be used. Refer to table above.

Step 4: Install flue, Air supply duct bracket, Air supply duct and connect to appliance

- Flue installation must meet the requirements of AS/NZS 5601.1:2013 must comply with all local council requirements and be installed and certified by a suitably qualified person.
- Refer to appropriate Fire Dept product specification for specific minimum requirements. Only follow the '**Wall cowl assembly details**' (below) if the flue is required to terminate through the wall.
- A 25mm clearance from combustible materials, 75mm clearance from wiring and plastic pipes and a minimum of 5mm from non-combustible materials is required when installing a flue system for any appliance supplied by The Fire Dept.
- The flue installation requires a restriction free cavity from the top of the firebox (flue spigot) to the outside atmosphere.
- Follow the **In-Line Fan assembly details** below.
- Air flow must be unobstructed from the firebox to the inner flue and from the heat shield to outer casing allowing air to circulate from the firebox to the flue casings to the atmosphere.
- Connect the **Air supply duct bracket** to the flue / wall spigot at the flue penetration to termination.
- Run the **100mm Aluminium Semi-Rigid Ducting** from the **Air supply duct bracket** to the **100mm air supply spigot** on the top of the fire box. Refer to appropriate Fire Dept product specification for specific fixing requirements.
- The **100mm Aluminium Semi-Rigid Ducting** will require a joint if the flue run is over 6 meters. Refer to appropriate Fire Dept product specification for specific fixing requirements.

In-Line Fan assembly details

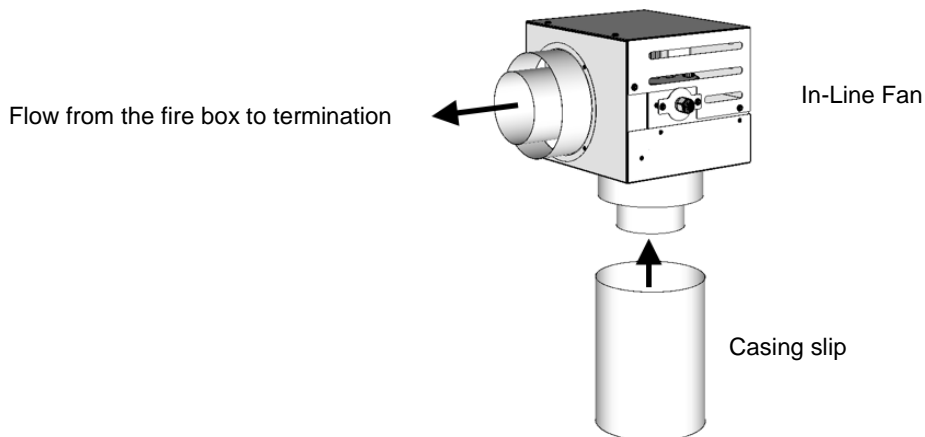

Step 1: Connect the flue and outer casing to the firebox

1. Make sure the In-line Fan has adequate access for future maintenance.
2. Run the flue from the fire to the location of the In-line Fan.
3. Run the outer casing from the fire to finish 90mm shorter than the flue.

Note: The outer casing must have the crimped end removed.

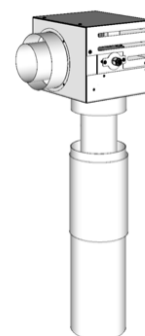

Step 2: Connect the In-Line Fan to the flue and outer casing

1. Fit the Casing slip over the outer casing.
2. Fit the flue over the inlet spigot to the In-Line Fan.

Note: The end of the flue must not finish past (inside) the line off the outer casing spigot.

3. Fix the flue to the inlet spigot at the In-Line Fan.

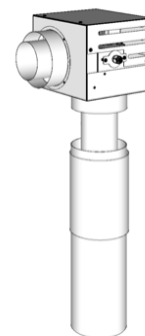

Step 3 Complete the flue installation

1. Slide the casing slip up the outer casing and over the outer casing spigot at the In-Line Fan.
2. Fix the casing slip to the outer casing and the In-Line fan
3. Complete the flue installation. Refer to appropriate Fire Dept product specification for fixing details and specific minimum requirements.



Air supply duct

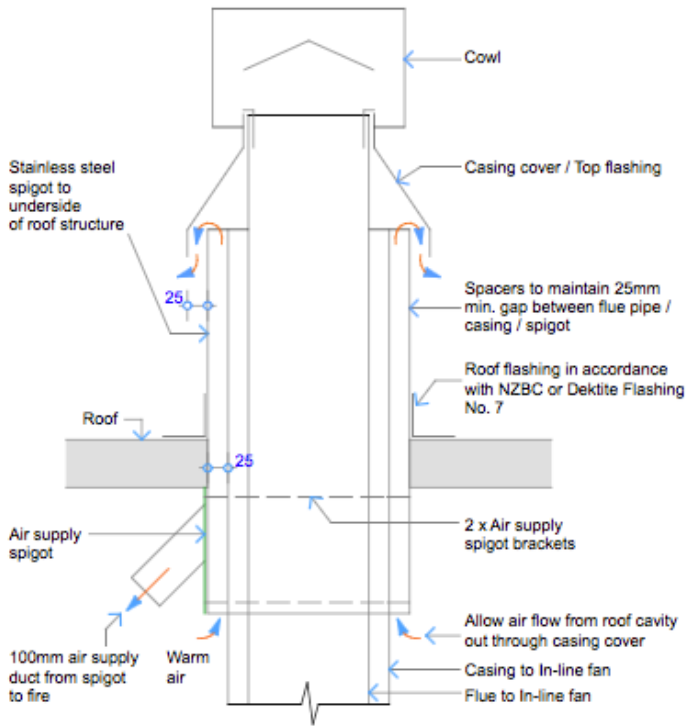

Detail - Air Ventilation through Casing cover/ Top flashing

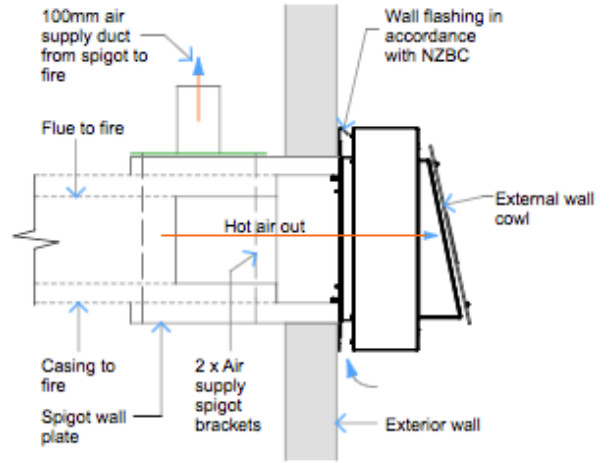

Detail - Air Ventilation through Wall

100mm Semi-Rigid Duct. 3m or 6m

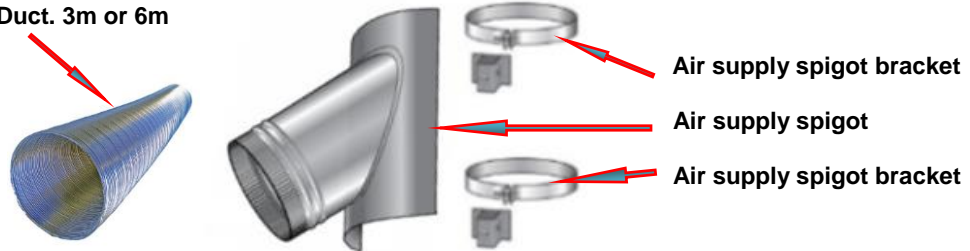

Air supply duct and bracket

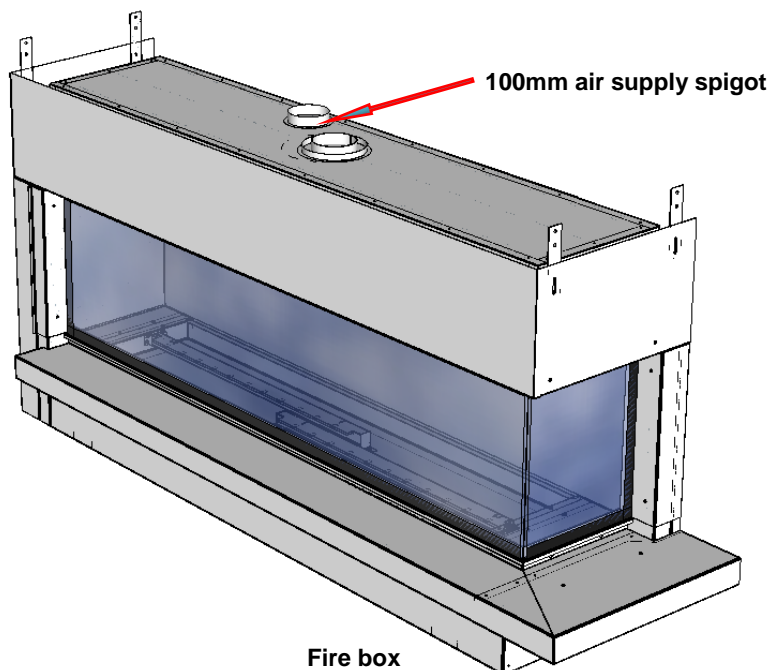

Fire box

Wall cowl assembly details

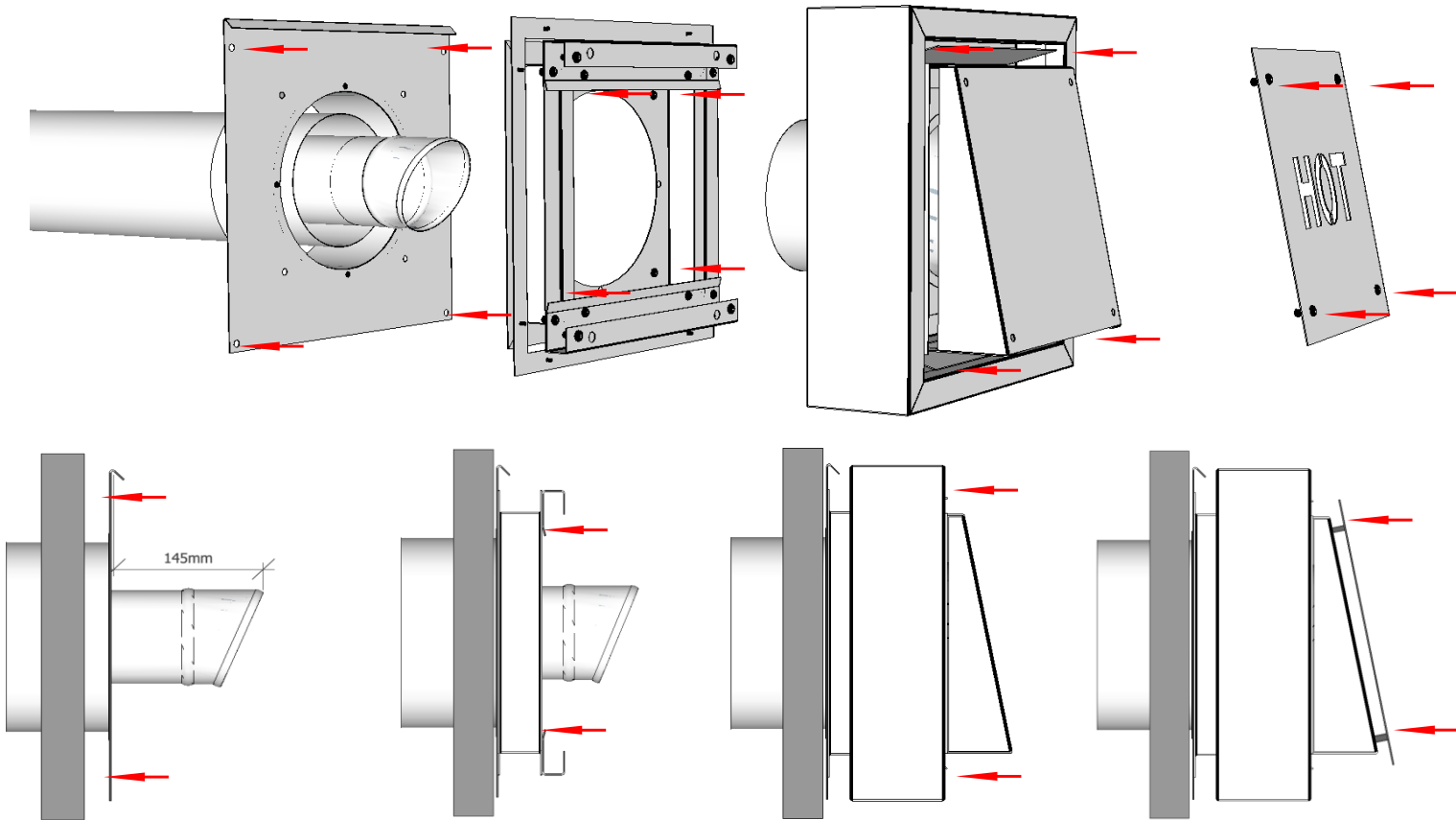

Step 1: Fix back panel to wall

1. Back panel must be flashed in accordance with NZBC.
2. Outer flue casing to finish flush with front of back panel.
3. Flue to finish 145mm out from back panel.

Step 2: Fix cowl support to back panel

1. Cowl support is fixed to back panel with 4 x 5mm cap screws
2. Seal between cowl support and back panel with heat proof sealer.

Step 3: Fix cowl to cowl support

1. Cowl is fixed to back panel with 4 x 5mm cap screws
2. The outer casing spigot (attached to the cowl) will slide into the outer flue casing.

Step 4: Fix HOT panel to the cowl.

1. Hot panel is fixed to back panel with 4 x 5mm cap screws

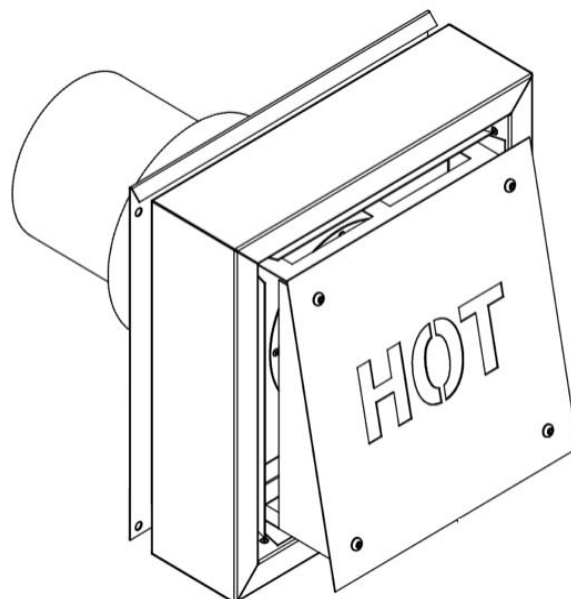

Step 5: Connect and test electrical supply

- All electrical connections must meet the requirements of AS/NZS 3000 standards and be installed and certified by a suitably qualified person.
- In order to access the electricals, it is necessary to first remove the glass and the burner tray.
- Follow the '**Glass removal process**' in this guide.
- Lift glass away from the appliance and lay flat in a safe place with insulating material facing down.
- Remove the burner tray by following the '**Burner Tray Removal Process**' in this guide.
- With the burner tray removed the electrical connections between the appliance and the switch can be seen, use 5 core (minimum 1mm) cable.
- Following these connection details, using the 5 core cable that has been run at site, connect the switch to the appliance
- **IMPORTANT: Before testing, ensure the gas valve is turned off.**



- The GD4 GR models have a glass failure safety switch, operated by a 3mm pin, at the base of each lower opening. The safety switch turns the appliance off if the glass is not in position. The 3mm pin will need to be held down to complete electrical testing. It is recommended that masking tape is used to hold the safety switch pin down.

NOTE: The masking tape must be removed once testing is completed.

Safety switch pin

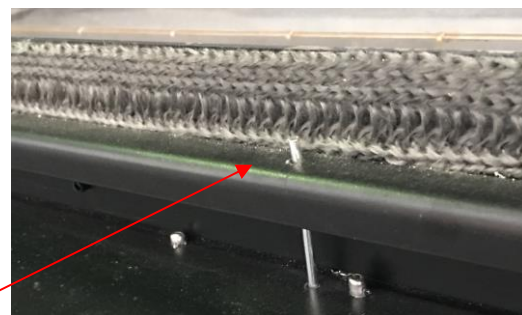

- Test electrical functions by switching the bottom High/Low switch to LOW, then switch the fire ON using the top On/Off switch.
- The fan will start and after approximately five seconds, the pilot will spark. Because the gas supply is turned off, the pilot will spark for approximately five seconds then automatically switch off. The fan will continue to operate.
- **NOTE:** GD4 GR models have a fan which runs in both LOW and HIGH settings.
- Switch to HIGH setting. Ensure that a red light appears on electrical connections block and the fan is operating.
- Switch the appliance off. Electrical testing is complete.
- Replace the burner tray by following the '**Burner tray installation process**' in this guide.
- Carefully replace glass by following the '**Glass installation process**' in this guide.

Step 6: Connect gas supply and commission

- **Gas installation, connection and commissioning must meet the requirements of AS/NZS 5601.1:2013 and be installed and certified by a suitably qualified person.**

- In order to access the gas supply and testing area, it is necessary to first remove the glass and the burner tray.

- Follow the '**Glass removal process**' in this guide.

- Remove the burner tray by following the '**Burner tray removal process**' in this guide.

- Connect 3/8 soft copper pipe to main valve.

- Leak test all joints.

- The GD4 GR models have a glass failure safety switch, operated by a 3mm pin, at the base of each lower opening. The safety switch turns the appliance off if the glass is not in position. The 3mm pin will need to be held down to complete commissioning. It is recommended that masking tape is used to hold the safety switch pin down.

NOTE: The masking tape must be removed once commissioning is completed

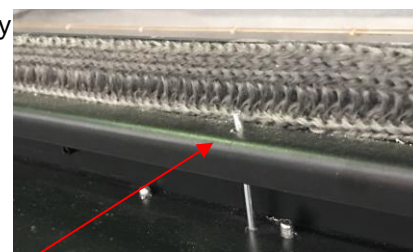

Safety switch pin

- Switch the appliance on.

- Test / adjust high first and then the low pressures against rating plate specifications.

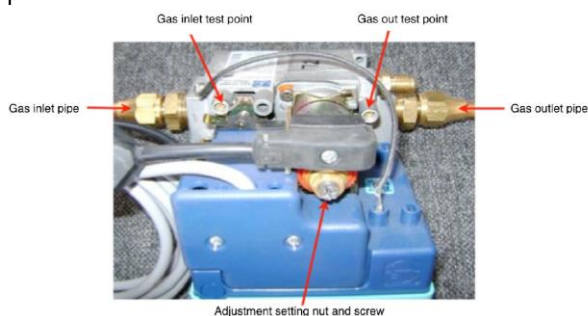

- In the unlikely event that the rating plate is not attached, **Do Not** commission the appliance and contact The Fire Dept immediately.

- Switch the appliance off.

- Replace the burner tray by following the '**Burner Tray Installation Process**' in this guide.

- Switch the appliance on.

- **Note:** due to lack of firebed and glass, it may be necessary to manually light burners.



- Switch the appliance off

- Lay firebed in accordance with instructions in Step 7 of this guide.

- Carefully replace glass by following the '**Glass installation process**' in this guide.

- Send gas certificate to appropriate person.

Step 7: Lay the firebed

- The GD4 GR has three firebed options: River Rocks, Beach Driftwood & Forest Logs.
- Particular care should be taken when placing the chosen firebed mediums into the burner tray. Failure to place the medium correctly may result in the fire performing inefficiently.
- Open the firebed cardboard box and identify firebox mediums.

River Rocks option has two firebed mediums:

Vermiculite – 3 bags

White rocks – large and small



Beach Driftwood option has three firebed mediums:

Vermiculite – 3 bags

White rocks – large and small

Driftwood – large and small



Forest Logs option has three firebed mediums:

Vermiculite – 3 bags

White rocks – large and small

Logs – large and small



How to lay Vermiculite

- In order to access the burner tray, it is necessary to first remove the glass.
- **Note:** glass removal is best carried out by two people.
- Follow the '**Glass removal process**' in this guide.
- Lift glass away from fire and lay flat in a safe place with insulating material facing down.

- Beginning in the middle at the back of the burner, carefully empty the bags of vermiculite into the burner tray.
- Ensure not to spill any vermiculite in cavities in front of and behind burner tray.
- Do not pour vermiculite directly into burner slots.



- Fill area behind burner up to top of burner tray. Use hand to spread out and push under burner.



- Fill up area in front of burner and gently pat down vermiculite to ensure it is spread evenly throughout the burner tray.



- Using a small Allen key (or similar), remove any vermiculite that may have fallen into burner slots.



- If natural gas is being used, leave burner slots slightly exposed.



- If LPG is being used, lightly cover burner slots in a thin layer of vermiculite by adding at back of burner tray and gently sweeping forward.



- If LPG is being used, small burner slots should be just visible.



- Vermiculite layer complete.



How to lay River Rocks Firebed - GD4 GR 1200

- Lay large rocks first, in these positions.



- Lay small rocks next, in these positions.



- With glass still removed, switch the appliance on at 'HIGH' setting to check how flame looks. The flame will take 10-20 seconds to light fully.



- **IMPORTANT:** the flame effect should look natural and non-uniform, running the entire length of the burner.
- Common flame effect issues are:
 - o Flame touching edge of burner tray.
 - o Missing flames along length of burner.
- Both these issues can be resolved by switching the appliance off and slightly repositioning rocks and logs at the problem areas.
- Repeat this switching on/off and repositioning until a natural and non-uniform flame effect is achieved.
- Once a natural and non-uniform flame effect is achieved, switch the appliance to 'LOW' setting and ensure the flame effect, although smaller, still looks good.
- Switch the appliance off and carefully replace glass by simply reversing the glass removal process.
- Switch the appliance on and check that flame effect still looks natural and non-uniform.
- **Note:** it is normal for the glass to mist a little when the appliance is first switched on. This will quickly disappear.

How to lay River Rocks Firebed - GD4 GR 1400 & 1600

- Lay large rocks first, in these positions.



- Lay small rocks next, in these positions.



- With glass still removed, switch the appliance on at 'HIGH' setting to check how flame looks. The flame will take 10-20 seconds to light fully.



- **IMPORTANT:** the flame effect should look natural and non-uniform, running the entire length of the burner.
- Common flame effect issues are:
 - o Flame touching edge of burner tray.
 - o Missing flames along length of burner.
- Both these issues can be resolved by switching the appliance off and slightly repositioning rocks and logs at the problem areas.
- Repeat this switching on/off and repositioning until a natural and non-uniform flame effect is achieved.
- Once a natural and non-uniform flame effect is achieved, switch the appliance to 'LOW' setting and ensure the flame effect, although smaller, still looks good.
- Switch the appliance off and carefully replace glass by simply reversing the glass removal process.
- Switch the appliance on and check that flame effect still looks natural and non-uniform.
- **Note:** it is normal for the glass to mist a little when the appliance is first switched on. This will quickly disappear.

How to lay Beach Driftwood Firebed - GD4 GR 1200

- Lay logs and large rocks first, in these positions



- Lay rocks next, in these positions.



- With glass still removed, switch the appliance on at 'HIGH' setting to check how flame looks. The flame will take 10-20 seconds to light fully.



- **IMPORTANT:** the flame effect should look natural and non-uniform, running the entire length of the burner.
- Common flame effect issues are:
 - o Flame touching edge of burner tray.
 - o Missing flames along length of burner.
- Both these issues can be resolved by switching the appliance off and slightly repositioning rocks and logs at the problem areas.
- Repeat this switching on/off and repositioning until a natural and non-uniform flame effect is achieved.
- Once a natural and non-uniform flame effect is achieved, switch the appliance to 'LOW' setting and ensure the flame effect, although smaller, still looks good.
- Switch the appliance off and carefully replace glass by simply reversing the glass removal process.
- Switch the appliance on and check that flame effect still looks natural and non-uniform.
- **Note:** it is normal for the glass to mist a little when the appliance is first switched on. This will quickly disappear.

How to lay Beach Driftwood Firebed - GD4 GR 1400 & 1600

- Lay logs and large rocks first, in these positions.



- Lay rocks next, in these positions.



- With glass still removed, switch the appliance on at 'HIGH' setting to check how flame looks. The flame will take 10-20 seconds to light fully.



- **IMPORTANT:** the flame effect should look natural and non-uniform, running the entire length of the burner.
- Common flame effect issues are:
 - o Flame touching edge of burner tray.
 - o Missing flames along length of burner.
- Both these issues can be resolved by switching the appliance off and slightly repositioning rocks and logs at the problem areas.
- Repeat this switching on/off and repositioning until a natural and non-uniform flame effect is achieved.
- Once a natural and non-uniform flame effect is achieved, switch the appliance to 'LOW' setting and ensure the flame effect, although smaller, still looks good.
- Switch the appliance off and carefully replace glass by simply reversing the glass removal process.
- Switch the appliance on and check that flame effect still looks natural and non-uniform.
- **Note:** it is normal for the glass to mist a little when the appliance is first switched on. This will quickly disappear.

How to lay Forest Logs Firebed - GD4 GR 1200

- Lay logs and large rocks first, in these positions.



- Lay rocks next, in these positions.



- With glass still removed, switch the appliance on at 'HIGH' setting to check how flame looks. The flame will take 10-20 seconds to light fully.



- **IMPORTANT:** the flame effect should look natural and non-uniform, running the entire length of the burner.
- Common flame effect issues are:
 - o Flame touching edge of burner tray.
 - o Missing flames along length of burner.
- Both these issues can be resolved by switching the appliance off and slightly repositioning rocks and logs at the problem areas.
- Repeat this switching on/off and repositioning until a natural and non-uniform flame effect is achieved.
- Once a natural and non-uniform flame effect is achieved, switch the appliance to 'LOW' setting and ensure the flame effect, although smaller, still looks good.
- Switch the appliance off and carefully replace glass by simply reversing the glass removal process.
- Switch the appliance on and check that flame effect still looks natural and non-uniform.
- **Note:** it is normal for the glass to mist a little when the appliance is first switched on. This will quickly disappear.

How to lay Forest Logs Firebed - GD4 GR 1400 & 1600

- Lay logs and large rocks first, in these positions.



- Lay rocks next, in these positions.



- With glass still removed, switch the appliance on at 'HIGH' setting to check how flame looks. The flame will take 10-20 seconds to light fully.



- **IMPORTANT:** the flame effect should look natural and non-uniform, running the entire length of the burner.
- Common flame effect issues are:
 - o Flame touching edge of burner tray.
 - o Missing flames along length of burner.
- Both these issues can be resolved by switching the appliance off and slightly repositioning rocks and logs at the problem areas.
- Repeat this switching on/off and repositioning until a natural and non-uniform flame effect is achieved.
- Once a natural and non-uniform flame effect is achieved, switch the appliance to 'LOW' setting and ensure the flame effect, although smaller, still looks good.
- Switch the appliance off and carefully replace glass by simply reversing the glass removal process.
- Switch the appliance on and check that flame effect still looks natural and non-uniform.
- **Note:** it is normal for the glass to mist a little when the appliance is first switched on. This will quickly disappear.



Step 8: Show owner how to operate appliance

- Following the GD4 GR Operating Instructions on the next page, show the owner how to switch the fire on and off, and how to switch between high and low settings.
- If the owner is not available, leave this manual by the fire.

NOTES:

GD4 GR OPERATING INSTRUCTIONS

The GD4 GR appliance has been designed to be simple to use. It is controlled by a wall switch, which must be installed by a qualified electrician.

To start fire:

- Press the on/off switch to the ON position.
- Press the high/low switch to the HIGH position.
- The electronic solenoid pack will start to click.
- Gas will then be released and ignited at the pilot valve.
- The safety sensor will allow the main burner pipe to ignite and flames will appear. The whole process will take between 10-20 seconds.
- Once the flame appears, it can be turned down to the low setting by pressing the high/low switch to LOW.

To shut down fire:

- Press the on/off switch to the OFF position.
- The gas will automatically be shut off to the pilot and the burner. The flame will then extinguish.
- The fan will continue to operate for approximately 10 minutes.

.....

TROUBLESHOOTING

Problem	Probable Cause	Action
Appliance doesn't start	<ol style="list-style-type: none"> 1. No gas supply 2. No power supply 3. Low or poor pilot flame 4. Signal from flame rectifier interrupted 5. Signal to sparker electrode interrupted 6. Incorrect sparker electrode gap 7. Glass not correctly positioned 	<ol style="list-style-type: none"> 1. Check gas supply 2. Check power supply 3. Check flame size and pressure 4. Check flame rectifier and wire to sit pack 5. Check sparker gap and wire to sit pack 6. Check sparker electrode gap is 3mm 7. Reposition glass
Appliance shuts down	<ol style="list-style-type: none"> 1. Low gas supply 2. Low or poor pilot flame 3. Signal to flame rectifier interrupted 	<ol style="list-style-type: none"> 1. Check gas supply 2. Check flame size and pilot flame pressure 3. Check flame rectifier and wire to sit pack
Flame in not running the full length of the burner	The firebed is not aligned to the burner	Re-lay the firebed to the specific model specifications detailed earlier in this guide
Flame is yellow and sooty	<ol style="list-style-type: none"> 1. Primary aeration ports have a blockage (LPG models only) 2. The firebed is not aligned to the burner 	<ol style="list-style-type: none"> 1. Check primary aeration ports for blockage and clear if required (LPG models only) 2. Re-lay the firebed to the specific model specifications detailed earlier in this guide
No flame at the pilot	Primary aeration ports have a blockage	Check primary aeration ports for blockage and clear if required

PRODUCT WARRANTY

IMPORTANT: Evidence of original purchase is required for warranty service.

WARRANTOR: 'The Fire Dept.' (Landscape Elements Ltd)
85 Newton Road
Mount Maunganui
PO Box 10275, Bayfair, Mount Maunganui

ELEMENT OF WARRANTY

'The Fire Dept.' warrants to the original retail owner for the duration of this warranty, its fireboxes, gas burner tray, lighters, (herein after referred to as the Product) to be free from defects in materials and craftsmanship with only the limitations or exclusions set out below.

WARRANTY

This warranty will be deemed invalid if the Product is;

- (A) Installed by someone other than an authorised Fire Dept agent.
- (B) Not operated appropriately or "over-fired" in a manner resulting in the firebox operating excessively hot.
- (C) Not serviced and maintained by a certified gas fitter every 12 months.
- (D) Damaged by accident, neglect or misuse,
- (E) Repaired by someone other than an authorised Fire Dept repair agent for a defect or malfunction covered by this warranty.
- (F) Modified, altered or used as part of any conversion kits, subassemblies, or any configurations not sold by 'The Fire Dept.'.
- (G) The product contains fire bricks and has not been subjected to the recommended first start-up and run-in procedure.
- (H) Used in conjunction with any equipment or parts or as part of a system not manufactured or supplied by 'The Fire Dept.'.
- (I) External powder-coating within 200m of the high tide mark and not lightly washed with warm soapy water every three months.

Indoor appliances (Gas & Wood)

'The Fire Dept.' warrants the mild steel firebox, galvanised steel outer skin and RHS Duragal steel support frame against defective materials and workmanship which would render it unfit for normal domestic use, from the date of purchase by the original consumer, for a period of 5 (five) years. Beyond normal heat-induced staining, tarnishing and mild warping, if a firebox, outer skin or support frame defect occurs, contact 'The Fire Dept.' and the defect will be repaired or replaced at our discretion with all costs covered.

'The Fire Dept.' warrants the SIT Pack (Gas regulator and controller) against defective materials and workmanship which would render it unfit for normal domestic use, from the date of purchase by the original consumer, for a period of 2 (two) years.

Components including fire medium, fans, tiles, glass and glass trim are warranted for a period of 2 (two) years from the date of original purchase, against defective materials and workmanship.

Outdoor appliances (Gas & Wood)

'The Fire Dept.' warrants the Mild Steel firebox, galvanised steel outer skin and RHS Duragal Steel support frame against defective materials and workmanship which would render it unfit for normal domestic use, from the date of purchase by the original consumer, for a period of 2 (two) years. Beyond normal heat-induced staining, tarnishing and mild warping, If a firebox, outer skin or support frame defect occurs, contact 'The Fire Dept.' and the defect will be repaired or replaced at our discretion with all costs covered.

'The Fire Dept.' warrants the SIT Pack (Gas regulator and controller) against defective materials and workmanship which would render it unfit for normal domestic use, from the date of purchase by the original consumer, for a period of 2 (two) years.

Components including fire medium, fans, tiles, glass and glass trim are warranted for a period of 2 (two) years from the date of original purchase for domestic use, against defective materials and workmanship.

STATEMENT OF REMEDY

In the event that the Product does not conform to this warranty at any time while this warranty is in effect, the Warrantor, at its discretion, will repair the defect or replace the part and return it to you without charge for parts or service. This warranty does not provide for reimbursement or payment of incidental or consequential damages.

This warranty does not in any way affect your rights under the Consumers Guarantee Act (New Zealand).