



GD6 Recessed Burner

Installation Guide

Operating Instructions

Warranty

GD6 RB Installation Guide, Operating Instructions & Warranty

IMPORTANT!

This gas appliance must be installed to **AS/NZS 5601.1:2013** by a qualified person and in accordance with these instructions. Failure to install the appliance correctly will void your warranty and may cause a fire. This appliance should not be modified under any circumstances.

Under no circumstances should any combustibles such as paper, wood or coal be used in this appliance.

It is recommended that you have this appliance serviced annually by a qualified technician.

Warranty repairs must be carried out by a 'The Fire Dept.' authorised technician.

This appliance must ALWAYS terminate/flue outdoors.

Young children, elderly or infirm should be supervised to ensure that they are careful with the appliance.

Clothing and other flammable materials should never be placed near the appliance.

Please note that parts (near the flame) of this appliance, particularly the steel surrounding, all panels to the face or around the front, become extremely hot during operation and can result in serious injury and burns if touched. It is therefore recommended that a fireguard complying with BS 8423:2002 is used in the presence of young children, the elderly or infirm.

NOTE: This GD6 RB appliance is fitted with an Oxyprotector (Oxygen depletion) pilot. Under NO circumstances should this pilot be replaced or removed.

The GD6 RB installation process consists of 7 steps	Page
Step 1: Ensure all components are correct and undamaged.	3
Step 2: Install plinth (if required).	3
Step 3: Install appliance into cavity	3
Burner tray removal process	4
Burner tray installation process	5
Weather housing	6
Firebox lining removal process (if required)	7
Step 4: Connect and test electrical supply	10
Step 5: Connect gas supply and commission	12
Step 6: Lay the firebed	13
How to lay River Rocks firebed	15
How to lay Beach Driftwood firebed	17
How to lay Forest Logs firebed	19
Step 7: Show owner how to operate appliance	21
Operating Instructions.	22
Troubleshooting	22
Warranty	23

Information in this installation guide may be subject to change without notice.
Please ensure that you have the current version before beginning installation.

If you have any queries, please contact 'The Fire Dept.' on 0800 888 550

Step 1: Unpack and ensure all components are correct and undamaged

- Firebox
- Box of firebed mediums

Step 2: Install plinth (if required)

- If the appliance is to sit on a plinth, ensure it is capable of supporting a 350kg load.
- There is no clearance requirement for the base of the appliance. It may safely sit directly upon combustible (eg. timber) and non-combustible (eg. concrete) materials.

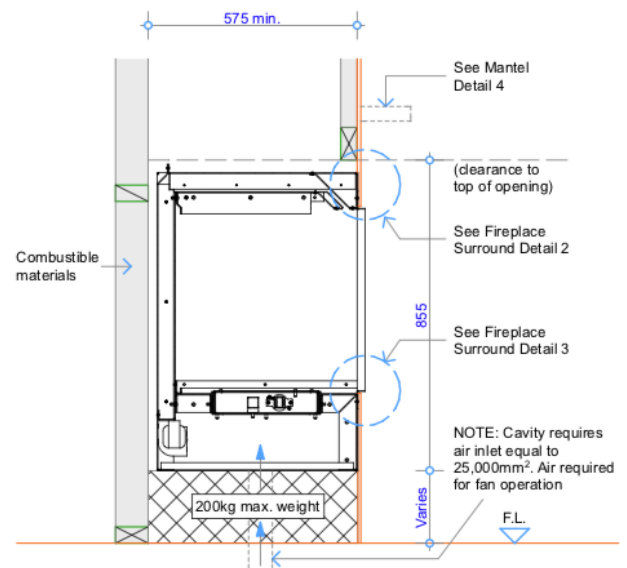



Step 3: Install appliance into cavity

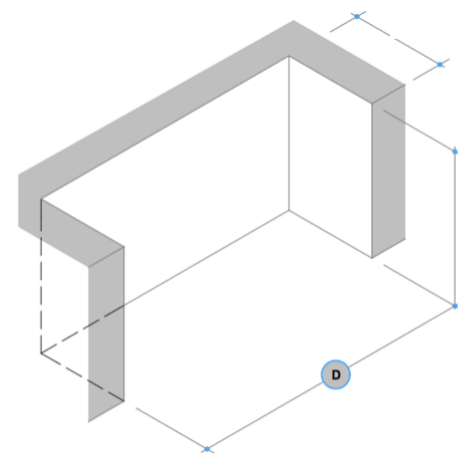

- **Important:** The cavity (that the fire box is to be installed into) must be weather-tight and free-draining and comply with the requirements of the New Zealand Building Codes E2 (External Moisture).
- Before installation, confirm all minimum clearances from the outside surfaces of the appliance to the surrounding enclosure are no closer than 25mm from combustible materials and 5mm from non-combustible materials.
- The exception to these minimum clearances is the base and the front surround panels of the appliance. The base can safely sit directly upon combustible (e.g. timber) and non-combustible (e.g. concrete) materials and the front surround panels can be placed hard against non-combustible materials. Please refer to the appropriate appliance specifications for all correct clearance requirements.
- Ensure the appliance has adequate air supply to the cavity under the burner. Check appropriate appliance specifications for air requirements.
- If a gas supply pipe has already been run to the cavity, ensure 1000mm of 3/8 soft copper tube is available at the centre of the cavity, as this is where the copper tube with the gas supply enters the appliance.
- If an electrical supply cable has already been run to the cavity (must be a minimum of 1.0mm 4 core cable), ensure that the cable reaches the centre of the cavity, as this is where it will enter the appliance.
- In order to access the fixing slots in the base of the appliance, and the gas and electrical connections, it is necessary to first remove the burner tray.



Fire Installation - Trim Sizes



Burner Tray Removal Process

	Cover and end cap removal	
<p>GD6 RB Pilot cover</p> <p>This model has one pilot cover.</p>	<ul style="list-style-type: none"> Remove the stainless steel pilot cover (2 x screws) at the pilot end of the burner. 	 <p>Pilot cover</p>
<p>GD6 RB Burner end caps</p> <p>This model has two end cap covers, one at each side of the burner.</p>	<ul style="list-style-type: none"> Remove the stainless steel burner end caps (3 x screws on each cap) at either end of the burner tray. 	 <p>Non pilot burner end Pilot burner end</p>

	LPG	Natural Gas
<p>GD6 RB 1200</p> <p>Input 35-45 MJ/h</p> <p>One gas injector at the pilot side of the burner tray.</p>	<ul style="list-style-type: none"> Remove the burner tray by carefully pushing it away from the pilot and lift the pilot end of the burner tray, lift the burner tray up and away from the pilot in one movement. Stand the burner tray on its end and lean against a stable surface. 	<ul style="list-style-type: none"> Remove the burner tray by carefully pushing it away from the pilot and lift the pilot end of the burner tray, lift the burner tray up and away from the pilot in one movement. Stand the burner tray on its end and lean against a stable surface.
<p>GD6 RB 1400</p> <p>Input 45-55 MJ/h</p> <p>Two gas injectors one at the right and one at left hand sides of the burner tray.</p>	<ul style="list-style-type: none"> Remove the burner tray by carefully pushing it away from the pilot and lift the pilot end of the burner tray, lift the burner tray up and away from the pilot in one movement. Ensure that the gas injector at the left hand side is not damaged as the burner tray is lifted out. Stand the burner tray on its end and lean against a stable surface. 	<ul style="list-style-type: none"> On the pilot side gas injector, loosen and spin back the 12mm brass nut away from the burner tray. <div style="text-align: center;">  <p>Pilot side Gas Injector</p> </div>
<p>GD6 RB 1600</p> <p>Input 55-65 MJ/h</p> <p>Two gas injectors one at the right and one at left hand sides of the burner tray.</p>	<ul style="list-style-type: none"> Remove the burner tray by carefully pushing it away from the pilot and lift the pilot end of the burner tray, lift the burner tray up and away from the pilot in one movement. Stand the burner tray on its end and lean against a stable surface. 	<ul style="list-style-type: none"> On the non-pilot side injector, loosen both the 12mm brass nuts all the way to the end of the injector. The injector will need to be pushed away from the burner tray. <div style="text-align: center;">  <p>Non-pilot side gas Injector</p> </div> <ul style="list-style-type: none"> Remove the burner tray by carefully pushing it away from the pilot and lift the pilot end of the burner tray, lift the burner tray up and away from the pilot in one movement. Stand the burner tray on its end and lean against a stable surface.

Burner Tray Installation Process

	LPG	Natural Gas
<p>GD6 RB 1200</p> <p>Input 35-45 MJ/h</p> <p>One gas injector at the pilot side of the burner tray.</p>	<ul style="list-style-type: none"> Install the burner tray by carefully lowering the end opposite from the pilot meanwhile holding up the pilot end, lower the burner tray down and move towards the pilot in one movement. Ensure the burner tray is located correctly into the burner bracket and the jets are aiming into the burner tube inlet holes. 	<ul style="list-style-type: none"> Install the burner tray by carefully lowering the end opposite from the pilot meanwhile holding up the pilot end, lower the burner tray down and move towards the pilot in one movement. Ensure the burner tray is located correctly into the burner bracket and the jets are aiming into the burner tube inlet holes. On the pilot side gas injector, gently tighten (do not over tighten) the 12mm brass nut closest to the burner tray.
<p>GD6 RB 1400</p> <p>Input 45-55 MJ/h</p> <p>Two gas injectors one at the right and one at left hand sides of the burner tray.</p>	<ul style="list-style-type: none"> Install the burner tray by carefully lowering the end opposite from the pilot meanwhile holding up the pilot end, lower the burner tray down and move towards the pilot in one movement. Ensure the burner tray is located correctly into the burner bracket and the jets are aiming into the burner tube inlet holes. 	<ul style="list-style-type: none"> Install the burner tray by carefully lowering the end opposite from the pilot meanwhile holding up the pilot end, lower the burner tray down and move towards the pilot in one movement. Ensure the burner tray is located correctly into the burner bracket and the jets are aiming into the burner tube inlet holes. On the non-pilot side injector, gently tighten both the 12mm brass nuts. The injector will pull towards the burner tray. On both the non-pilot and pilot side gas injectors, gently tighten (do not over tighten) the 12mm brass nuts closest to the burner tray.
<p>GD6 RB 1600</p> <p>Input 55-65 MJ/h</p> <p>Two gas injectors one at the right and one at left hand sides of the burner tray.</p>		 <p style="text-align: center;">Non-pilot side Gas Injector Pilot side Gas Injector</p>

Cover and end cap installation	
<p>GD6 RB Oxygen Depletion Pilot</p>	<ul style="list-style-type: none"> Under NO circumstances should the pilot be replaced or removed,  <p style="text-align: center;">Oxygen depletion pilot</p>
<p>GD6 RB Pilot cover</p> <p>This model has one pilot cover.</p>	<ul style="list-style-type: none"> Replace the stainless steel pilot cover (2 x screws) at the pilot end of the burner.  <p style="text-align: center;">Pilot cover</p>
<p>GD6 RB Burner end caps</p> <p>This model has two end cap covers, One at each side of the burner</p>	<ul style="list-style-type: none"> Replace the stainless steel burner end caps (3 x screws on each cap) at either end of the burner.  <p style="text-align: center;">Non pilot burner end cap Pilot burner end cap</p>

Weather Housing

- The gas supply pipe will need to be run into the weather housing under the burner, as this is where the copper tube with the gas supply connects to the GD6 burner.
- The electrical supply cable will need to be run into the weather housing (must be a minimum of 1.0mm 4 core cable), ensure 1000mm of cable is at the centre of the cavity, as this is where it will connect to the GD6 burner.
- The electrical cable connects to the fan/fans (1.0mm 3 core cable).
- In order to access the gas and electrical connections inside the weather housing, it is necessary to first remove the burner.
- Remove the outer front cover (3 x screws across the top and 2 x screws across the front).
- To refit the outer front cover, simply reverse the removal process.

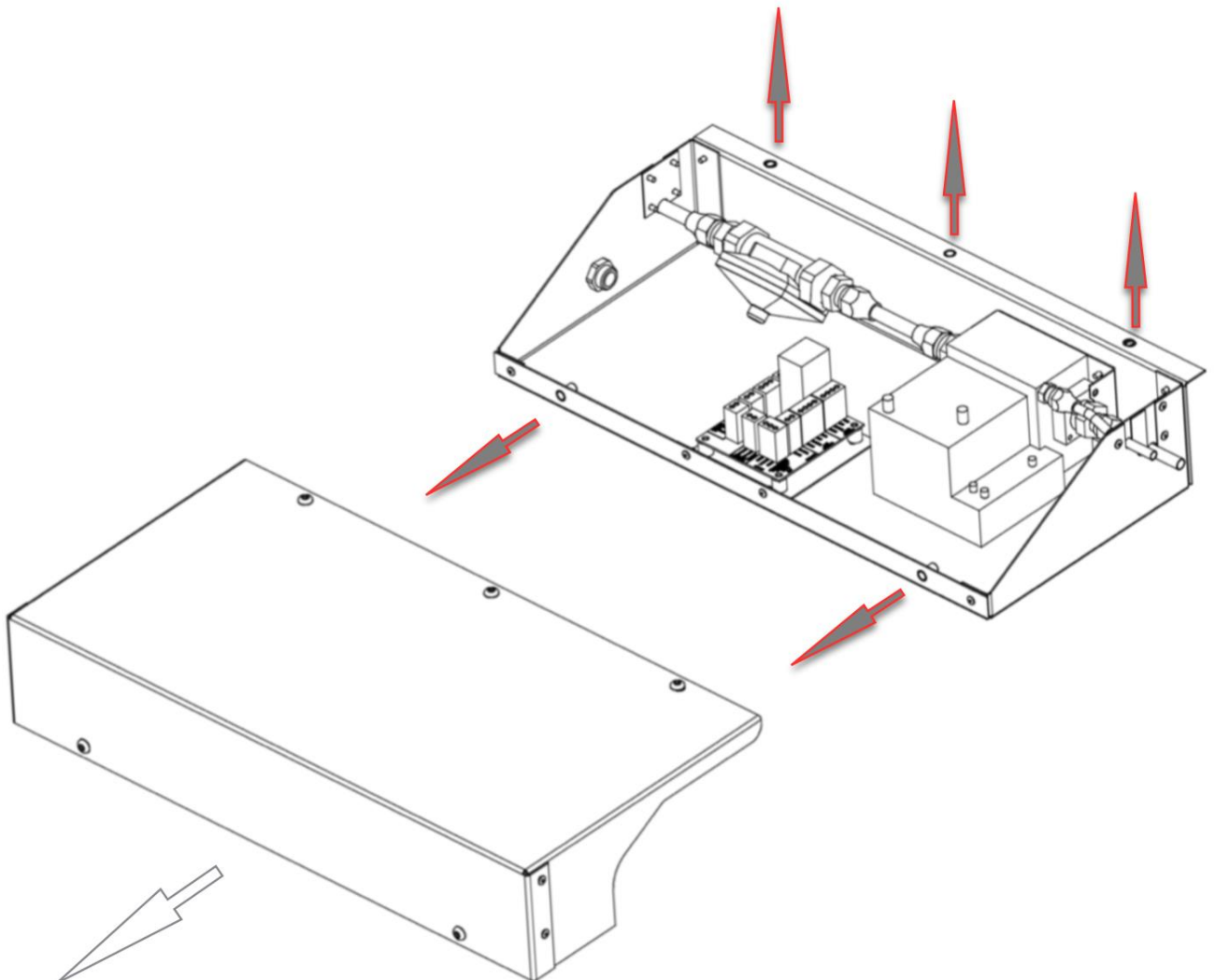

Firebox Lining Removal Process (if required)

- In some circumstances (eg. the need to reduce overall weight so the appliance can be lifted up stairs), it may be necessary to remove (then replace) the firebox lining.
.....
- The GD6 has four fire box lining options: Dark tile, Steel, and Client-supplied.
- Particular care should be taken when removing and replacing the chosen Fire lining into the appliance. Failure to place the firebox lining correctly may result in the appliance performing inefficiently.

Dark tile lining (supplied as default option):

Black slate – 9mm.

Size – 600mm x 600mm cut to suit.

Finish – Dark slate.



Steel lining:

Mild steel – 2mm.

Size – Cut and folded to suit appliance.

Finish – Matt black paint.



Client-supplied lining: Requirements

Non-combustible and heat-resistant.

Size – maximum thickness 10mm.

Size – Minimum height for tiles 500mm.

All measurements must be confirmed on site.

Finish – robust and self-supporting.



Example of a client-supplied fire box lining

This GD6 RB appliance is supplied with the chosen firebox lining or ready for the client-supplied firebox lining.

Note: Take care when removing the top fixing bracket. The top of the Fire box lining will fall forward with the bracket removed.

1. Remove the top three lining fixing brackets. 5mm cap screws.
2. Allow the top of the lining to fall forward.
3. Carefully lift the lining up and out of the base channel.
4. Place the lining in a safe place.
5. The lining on the base (either side of the burner) fits into the channel.
6. Remove the base lining by carefully lifting the lining at the joint or at one end.
7. To refit the firebox lining simply reverse the removal process.

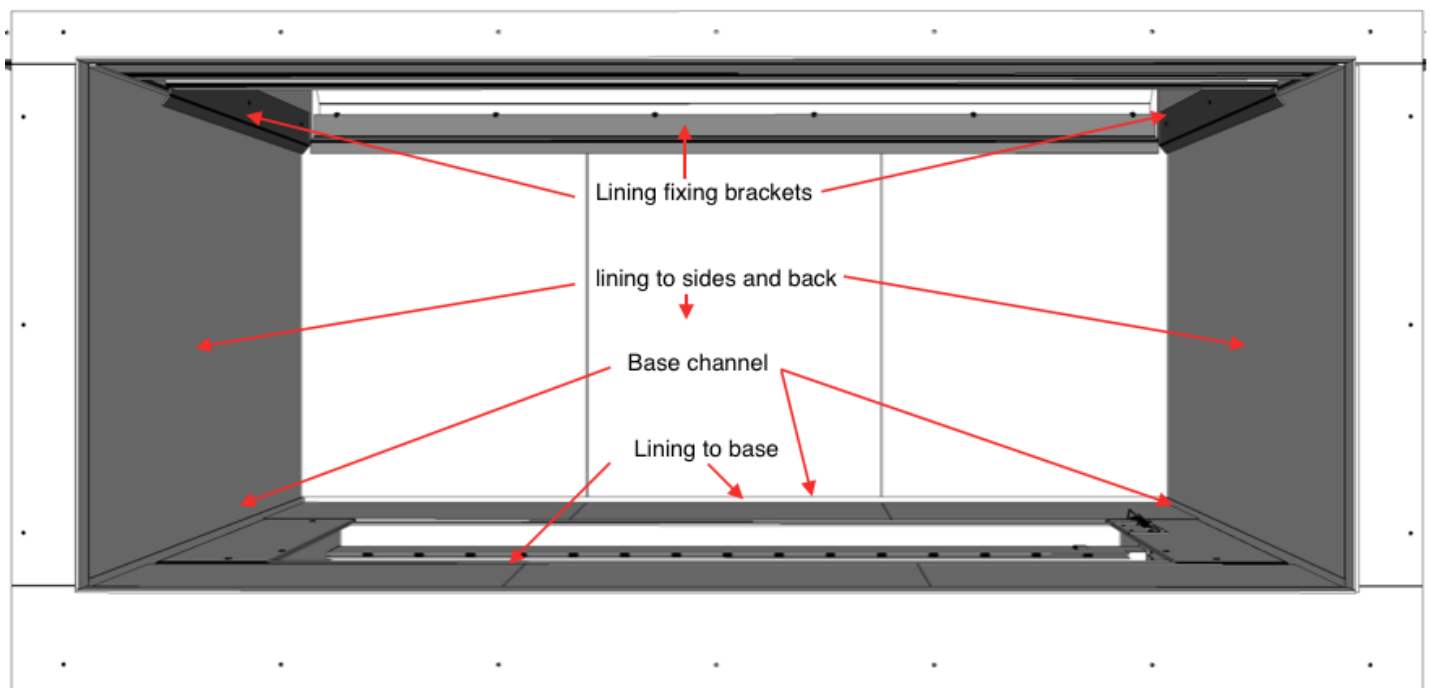

- Slide appliance into position and ensure that it complies with the minimum clearances required (25mm for combustibles, 5mm for non-combustibles) to the surrounding enclosure. The exception to these minimum clearances is the base and the front surround panels of the fire, the base can safely sit directly upon combustible (e.g. timber) and non-combustible (e.g. concrete) materials, refer to the appropriate appliance specification for the correct clearance requirements. Ensure the framing is capable of supporting a 350kg load.
- In order to provide maximum positioning flexibility, the base of the appliance has two fixing brackets with two 30mm long slots in each.
- The two fixing brackets will clamp the appliance into position. Locate the fixing brackets and mark out and drill fixing holes through the 30mm slots in the fixing brackets. Ensure holes are drilled in the centre of the slots to allow maximum positioning flexibility. Clear out any debris from drilling.

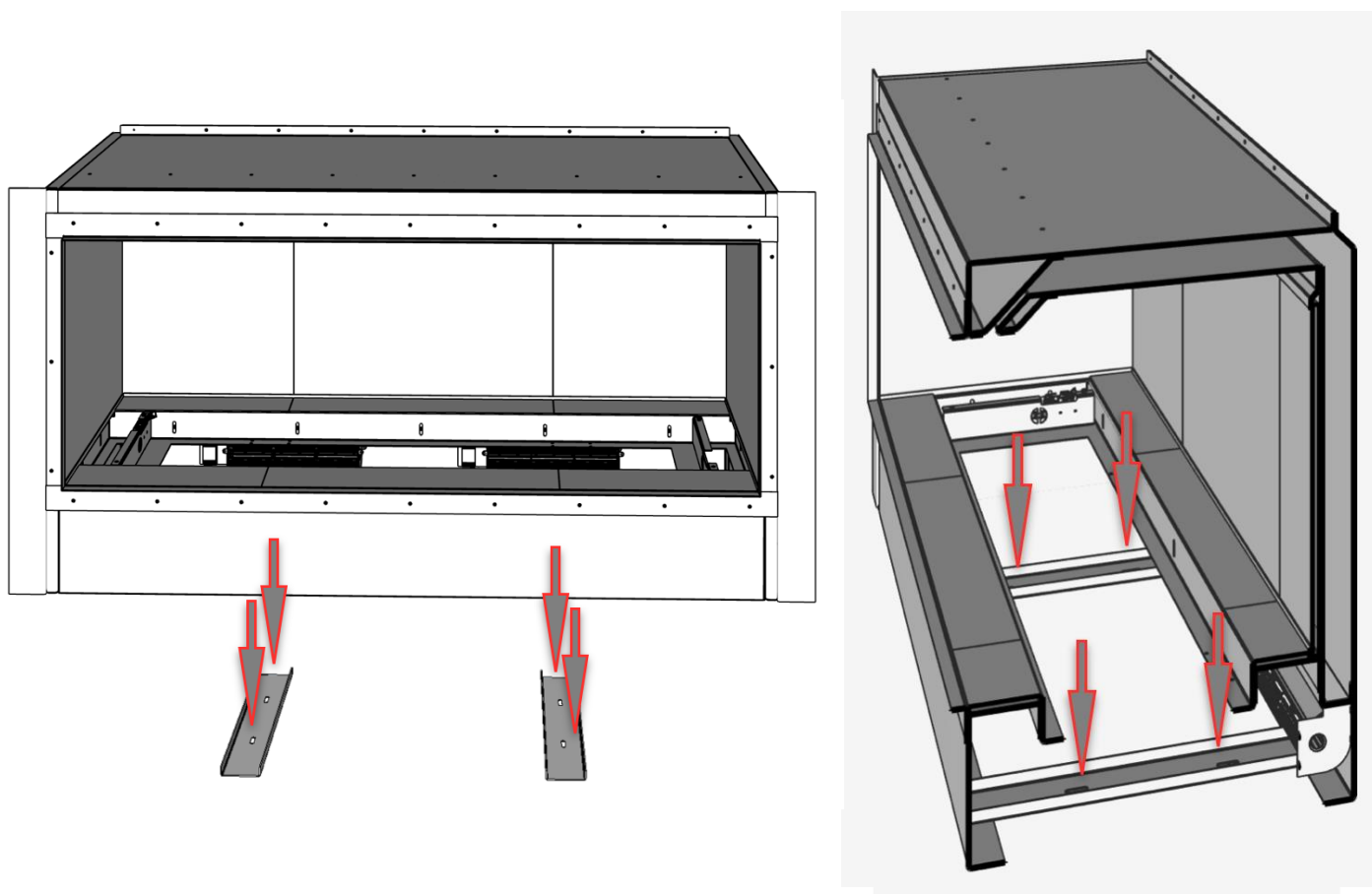

- Ensure the appliance is level and pack up corners to suit where necessary. Check and ensure unit is level.
- Once the appliance is level, fix bolts/screws into hearth.
- Replace the burner tray by following the '**Burner Tray Installation Process**' in this guide.

Step 4: Connect and test electrical supply

- All electrical connections must meet the requirements of AS/NZS 3000 standards and be installed and certified by a suitably qualified person.
- In order to access the electricals, it is necessary to first remove the burner tray and weather housing front cover.
- Remove the burner tray and weather housing front cover by following the '**Burner Tray Removal Process**' and '**Weather Housing**' of this guide.
- With the burner tray and weather housing front cover removed the electrical connections between the appliance and the switch can be seen, use 4 core (minimum 1mm) cable.
- Following these connection details, using the 4 core cable that has been run at site, connect the switch to the appliance.
- **IMPORTANT: Before testing, ensure the gas valve is turned off.**



- Test electrical functions by switching the bottom High/Low switch to LOW, then switch the appliance ON using the top On/ Off switch.
- After approximately five seconds, the pilot will spark. Because the gas supply is turned off, the pilot will spark for approximately five seconds then automatically switch off.
- **NOTE:** GD6 models have both LOW and HIGH settings.
- Switch to HIGH setting. Ensure that a red light appears on the electrical connections block.
- Switch the appliance off. Electrical testing is complete.
- Replace the burner tray and weather housing cover by following the '**Burner tray installation process**' and '**Weather Housing**' in this guide.

ITEM	QTY	DESCRIPTION
1	1	Sit 843 Sigma
2	1	Switched controller (Speed)
3	2	High speed fan
4	1	Electrical controller
5	1	SIT - Oxy pilot

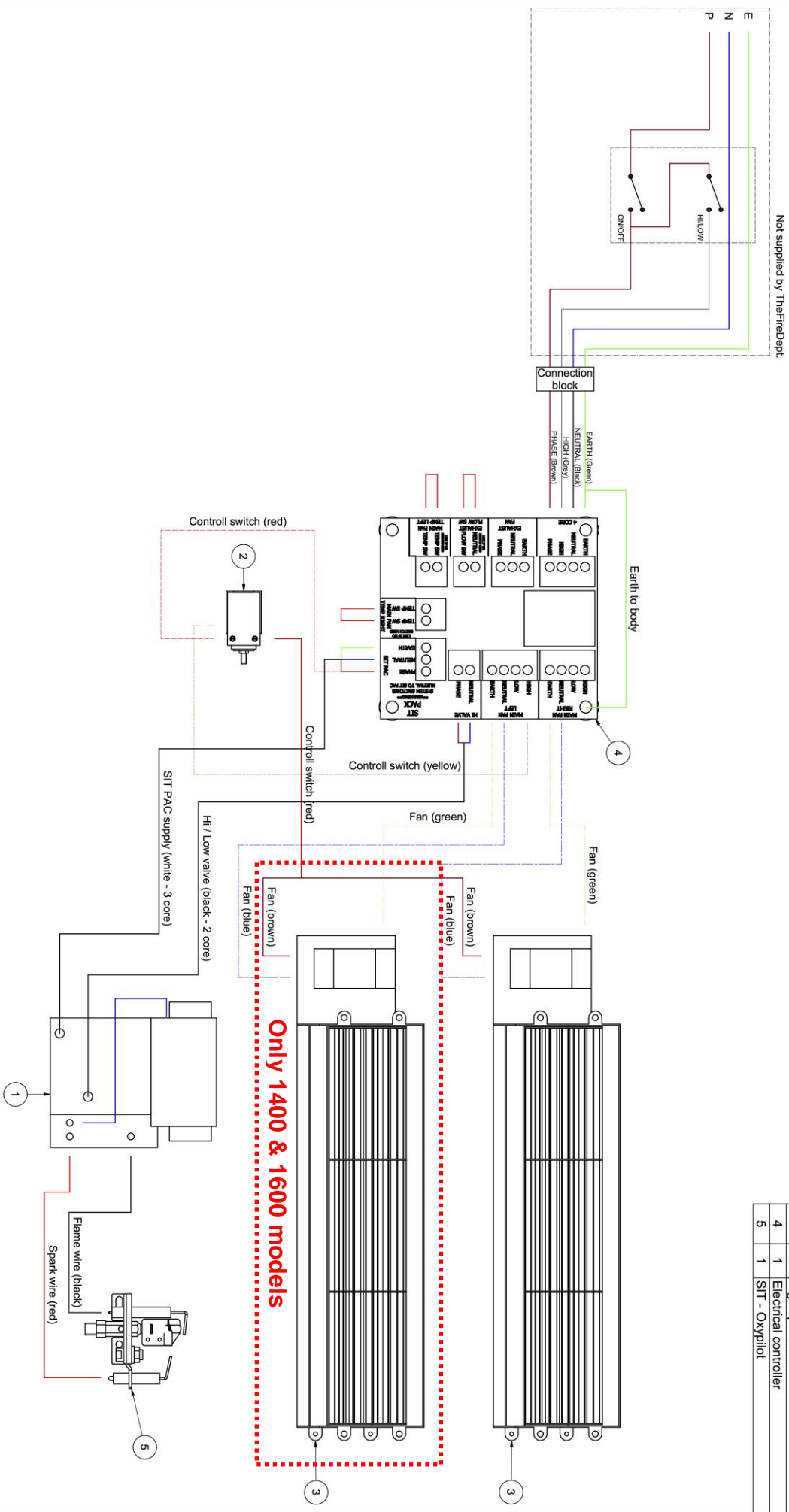

COPYRIGHT®		DRAWING No.		REFERENCE DRAWINGS	
THIS DRAWING IS THE PROPERTY OF THE FIRE DEPT. ANY REUSE OR ALTERATION WITHOUT THE PERMISSION OF THE FIRE DEPT. IS STRICTLY FORBIDDEN. UNDERSTANDING THAT IT IS NOT TO BE COPIED OR COMMUNICATED TO ANY OTHER PERSON WITHOUT THE PERMISSION OF THE PROPRIETORS.		REV No.		DATE	
		0		2019/03/06	
		1		2019/07/29	
		BY J.S.		ISSUED FOR MANUFACTURE	
		BY J.S.		DIAGRAM LINE OCCURS UPDATED	
		BY		DATE	
		BY		DATE	
		BY		DATE	
Client: THE FIRE DEPT - STANDARD SERIES		Project: GD6		Title: Electrical line diagram	
Drawn: J.SCHOEMAN		Date: 6/03/2018		Scale: on/A2	
Appr:		Date:		Sheet 1 of 1	
Drawing No. GD6-1400-451		Revision			

Step 5: Connect gas supply and commission

- Gas installation, connection and commissioning must meet the requirements of AS/NZS 5601.1:2013 and be installed and certified by a suitably qualified person.
- In order to access the gas supply and testing area, it is necessary to first remove the burner tray and weather housing front cover.
- Remove the burner tray and weather housing front cover by following the '**Burner Tray Removal Process**' and '**Weather Housing**' of this guide.
- Connect 3/8 soft copper pipe to main valve.
- Leak test all joints.
- Switch the appliance on.
- Test/adjust high first and then the low pressures against rating plate specifications.

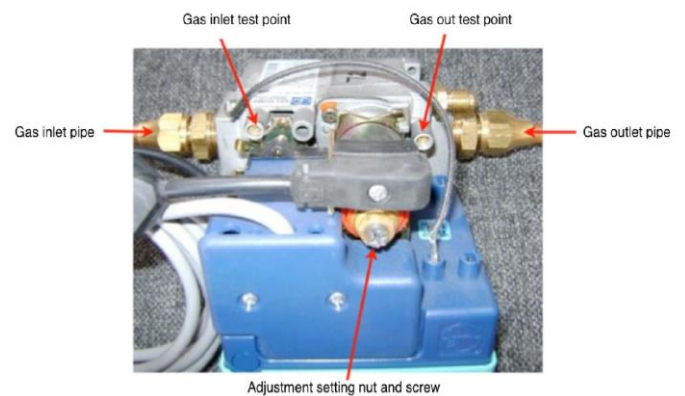

- In the unlikely event that the rating plate is not attached, **Do Not** commission the appliance and contact 'The Fire Dept.' immediately.
- Switch the appliance off.
- Replace the burner tray and weather housing cover by following the '**Burner Tray Installation Process**' and '**Weather Housing**' in this guide.
- Switch the appliance on.
- **Note:** due to lack of firebed, it may be necessary to manually light burners.



- Switch the appliance off.
- Lay firebed in accordance with instructions in Step 6 of this guide.
- Send gas certificate to the appropriate person.

Step 6: Lay the firebed

- The GD6 Recessed Burner has three firebed options: River Rocks, Beach Driftwood & Forest Logs.
- Particular care should be taken when placing the chosen firebed mediums into the burner tray. Failure to place the medium correctly may result in the appliance performing inefficiently.
- Open the firebed cardboard box and identify firebox mediums.

River Rocks option has two firebed mediums:

Clay balls – 3 bags

White rocks – large and small



Beach Driftwood option has three firebed mediums:

Clay balls – 3 bags

White rocks – large and small

Driftwood – large and small



Forest Logs option has three firebed mediums:

Clay balls – 3 bags

White rocks – large and small

Logs – large and small



How to lay clay balls

- Beginning in the middle at the back of the burner, carefully empty the bags of clay balls into the burner tray.
- Ensure not to spill any clay balls in cavities in front of and behind burner tray.
- Do not pour clay balls directly over burner slots.



- Fill the burner up to top of burner tray. Use hand to spread out and push under burner.



- Using a small Allen key (or similar), remove any dust that may have fallen into burner slots.



- If natural gas is being used, leave burner slots slightly exposed.



- If LPG is being used, lightly cover burner slots in a thin layer of clay balls by adding at back of burner tray and gently sweeping forward.



- Clay balls layer complete.



How to lay River Rocks Firebed – GD6 1200

- Lay large rocks first, in these positions.



- Lay small rocks next, in these positions.



- Switch the appliance on at 'HIGH' setting to check how flame looks. The flame will take 10-20 seconds to light fully.



- **IMPORTANT:** the flame effect should look natural and non-uniform, running the entire length of the burner.
- Common flame effect issues are:
 - o Flame touching edge of burner tray.
 - o Missing flames along length of burner.
- Both these issues can be resolved by switching the appliance off and slightly repositioning rocks and logs at the problem areas.
- Repeat this switching on/off and repositioning until a natural and non-uniform flame effect is achieved.
- Once a natural and non-uniform flame effect is achieved, switch the appliance to 'LOW' setting and ensure the flame effect, although smaller, still looks good.
- Switch the appliance off.

How to lay River Rocks Firebed – GD6 1400 & 1600

- Lay large rocks first, in these positions.



- Lay small rocks next, in these positions.



- Switch the appliance on at 'HIGH' setting to check how flame looks. The flame will take 10-20 seconds to light fully.



- **IMPORTANT:** the flame effect should look natural and non-uniform, running the entire length of the burner.
- Common flame effect issues are:
 - o Flame touching edge of burner tray.
 - o Missing flames along length of burner.
- Both these issues can be resolved by switching the appliance off and slightly repositioning rocks and logs at the problem areas.
- Repeat this switching on/off and repositioning until a natural and non-uniform flame effect is achieved.
- Once a natural and non-uniform flame effect is achieved, switch the appliance to 'LOW' setting and ensure the flame effect, although smaller, still looks good.
- Switch the appliance off.

How to lay Beach Driftwood Firebed – GD6 1200

- Lay logs and large rocks first, in these positions



- Lay rocks next, in these positions.



- Switch the appliance on at 'HIGH' setting to check how flame looks. The flame will take 10-20 seconds to light fully.



- **IMPORTANT:** the flame effect should look natural and non-uniform, running the entire length of the burner.
- Common flame effect issues are:
 - o Flame touching edge of burner tray.
 - o Missing flames along length of burner.
- Both these issues can be resolved by switching the appliance off and slightly repositioning rocks and logs at the problem areas.
- Repeat this switching on/off and repositioning until a natural and non-uniform flame effect is achieved.
- Once a natural and non-uniform flame effect is achieved, switch the appliance to 'LOW' setting and ensure the flame effect, although smaller, still looks good.
- Switch the appliance off.

How to lay Beach Driftwood Firebed – GD6 1400 & 1600

- Lay logs and large rocks first, in these positions.



- Lay rocks next, in these positions.



- Switch the appliance on at 'HIGH' setting to check how flame looks. The flame will take 10-20 seconds to light fully.



- **IMPORTANT:** the flame effect should look natural and non-uniform, running the entire length of the burner.
- Common flame effect issues are:
 - o Flame touching edge of burner tray.
 - o Missing flames along length of burner.
- Both these issues can be resolved by switching the appliance off and slightly repositioning rocks and logs at the problem areas.
- Repeat this switching on/off and repositioning until a natural and non-uniform flame effect is achieved.
- Once a natural and non-uniform flame effect is achieved, switch the appliance to 'LOW' setting and ensure the flame effect, although smaller, still looks good.
- Switch the appliance off.

How to lay Forest Logs Firebed – GD6 1200

- Lay logs and large rocks first, in these positions.



- Lay rocks next, in these positions.



- Switch the appliance on at 'HIGH' setting to check how flame looks. The flame will take 10-20 seconds to light fully.



- **IMPORTANT:** the flame effect should look natural and non-uniform, running the entire length of the burner.
- Common flame effect issues are:
 - o Flame touching edge of burner tray.
 - o Missing flames along length of burner.
- Both these issues can be resolved by switching the appliance off and slightly repositioning rocks and logs at the problem areas.
- Repeat this switching on/off and repositioning until a natural and non-uniform flame effect is achieved.
- Once a natural and non-uniform flame effect is achieved, switch the appliance to 'LOW' setting and ensure the flame effect, although smaller, still looks good.
- Switch the appliance off.

How to lay Forest Logs Firebed – GD6 1400 & 1600

- Lay logs and large rocks first, in these positions.



- Lay rocks next, in these positions.



- Switch the appliance on at 'HIGH' setting to check how flame looks. The flame will take 10-20 seconds to light fully.



- **IMPORTANT:** the flame effect should look natural and non-uniform, running the entire length of the burner.
- Common flame effect issues are:
 - o Flame touching edge of burner tray.
 - o Missing flames along length of burner.
- Both these issues can be resolved by switching the appliance off and slightly repositioning rocks and logs at the problem areas.
- Repeat this switching on/off and repositioning until a natural and non-uniform flame effect is achieved.
- Once a natural and non-uniform flame effect is achieved, switch the appliance to 'LOW' setting and ensure the flame effect, although smaller, still looks good.
- Switch the appliance off.

Step 7: Show owner how to operate appliance

- Following the GD6 Recessed Burner Operating Instructions on the next page, show the owner how to switch the appliance on and off, and how to switch between high and low settings.
- If the owner is not available, leave this manual by the appliance.

NOTES:

GD6 RECESSED BURNER OPERATING INSTRUCTIONS

This GD6 appliance has been designed to be simple to use. It is controlled by a wall switch, which must be installed by a qualified electrician.

To start appliance:

- Press the on/off switch to the ON position.
- Press the high/low switch to the HIGH position.
- The electronic solenoid pack will start to click.
- Gas will then be released and ignited at the pilot valve.
- The safety sensor will allow the main burner pipe to ignite and flames will appear. The whole process will take between 10-20 seconds.
- Once the flame appears, it can be turned down to the low setting by pressing the high/low switch to LOW.

To shut down appliance:

- Press the on/off switch to the OFF position.
- The gas will automatically be shut off to the pilot and the burner. The flame will then extinguish.

.....

TROUBLESHOOTING

Problem	Probable Cause	Action
Appliance shuts down after continuous running.	Low Oxygen supplying to the fire.	1. Do not attempt to restart the fire.  2. Open all doors and windows. 3. Call gas-fitter.
Appliance doesn't start	1. No gas supply 2. No power supply 3. Low or poor pilot flame 4. Signal from flame rectifier interrupted 5. Signal to sparker electrode interrupted 6. Incorrect sparker electrode gap	1. Check gas supply 2. Check power supply 3. Check flame size and pressure 4. Check flame rectifier and wire to sit pack 5. Check sparker gap and wire to sit pack 6. Check sparker electrode gap is 3mm
Appliance shuts down	1. Low gas supply 2. Low or poor pilot flame 3. Signal to flame rectifier interrupted	1. Check gas supply 2. Check flame size and pilot flame pressure 3. Check flame rectifier and wire to sit pack
Flame in not running the full length of the burner	The firebed is not aligned to the burner	Re-lay the firebed to the specific model specifications detailed earlier in this guide
Flame is yellow and sooty	1. Primary aeration ports have a blockage (LPG models only) 2. The firebed is not aligned to the burner	1. Check primary aeration ports for blockage and clear if required (LPG models only) 2. Re-lay the firebed to the specific model specifications detailed earlier in this guide
No flame at the pilot	Primary aeration ports have a blockage	Check primary aeration ports for blockage and clear if required

PRODUCT WARRANTY

IMPORTANT: Evidence of original purchase is required for warranty service.

WARRANTOR: 'The Fire Dept.' (Landscape Elements Ltd)
85 Newton Road
Mount Maunganui
PO Box 10275, Bayfair, Mount Maunganui

ELEMENT OF WARRANTY

'The Fire Dept.' warrants to the original retail owner for the duration of this warranty, its fireboxes, gas burner tray, lighters, (herein after referred to as the Product) to be free from defects in materials and craftsmanship with only the limitations or exclusions set out below.

WARRANTY

This warranty will be deemed invalid if the Product is;

- (A) Installed by someone other than an authorised Fire Dept agent.
- (B) Not operated appropriately or "over-fired" in a manner resulting in the firebox operating excessively hot.
- (C) Not serviced and maintained by a certified gas fitter every 12 months.
- (D) Damaged by accident, neglect or misuse,
- (E) Repaired by someone other than an authorised Fire Dept repair agent for a defect or malfunction covered by this warranty.
- (F) Modified, altered or used as part of any conversion kits, subassemblies, or any configurations not sold by 'The Fire Dept.'.
- (G) The product contains fire bricks and has not been subjected to the recommended first start-up and run-in procedure.
- (H) Used in conjunction with any equipment or parts or as part of a system not manufactured or supplied by 'The Fire Dept.'.
- (I) External powder-coating within 200m of the high tide mark and not lightly washed with warm soapy water every three months.

Indoor appliances (Gas & Wood)

'The Fire Dept.' warrants the mild steel firebox, galvanised steel outer skin and RHS Duragal steel support frame against defective materials and workmanship which would render it unfit for normal domestic use, from the date of purchase by the original consumer, for a period of 5 (five) years. Beyond normal heat-induced staining, tarnishing and mild warping, if a firebox, outer skin or support frame defect occurs, contact 'The Fire Dept.' and the defect will be repaired or replaced at our discretion with all costs covered.

'The Fire Dept.' warrants the SIT Pack (Gas regulator and controller) against defective materials and workmanship which would render it unfit for normal domestic use, from the date of purchase by the original consumer, for a period of 2 (two) years.

Components including fire medium, fans, tiles, glass and glass trim are warranted for a period of 2 (two) years from the date of original purchase, against defective materials and workmanship.

Outdoor appliances (Gas & Wood)

'The Fire Dept.' warrants the Mild Steel firebox, galvanised steel outer skin and RHS Duragal Steel support frame against defective materials and workmanship which would render it unfit for normal domestic use, from the date of purchase by the original consumer, for a period of 2 (two) years. Beyond normal heat-induced staining, tarnishing and mild warping, if a firebox, outer skin or support frame defect occurs, contact 'The Fire Dept.' and the defect will be repaired or replaced at our discretion with all costs covered.

'The Fire Dept.' warrants the SIT Pack (Gas regulator and controller) against defective materials and workmanship which would render it unfit for normal domestic use, from the date of purchase by the original consumer, for a period of 2 (two) years.

Components including fire medium, fans, tiles, glass and glass trim are warranted for a period of 2 (two) years from the date of original purchase for domestic use, against defective materials and workmanship.

STATEMENT OF REMEDY

In the event that the Product does not conform to this warranty at any time while this warranty is in effect, the Warrantor, at its discretion, will repair the defect or replace the part and return it to you without charge for parts or service. This warranty does not provide for reimbursement or payment of incidental or consequential damages.

This warranty does not in any way affect your rights under the Consumers Guarantee Act (New Zealand).