



WD1 Open Front and Right (Concrete and Timber Cavity)

**Installation Guide
Operating Instructions
Warranty**

WD1 Open Front and Right (Concrete and Timber Cavity) Installation Guide, Operating Instructions & Warranty

IMPORTANT!

This wood appliance must be installed to **AS/NZS 2918:2001** by a qualified person and in accordance with these instructions. Failure to install the appliance correctly will void your warranty and may cause a fire. This appliance should not be modified under any circumstances.

It is recommended that you have this appliance serviced annually by a qualified technician.

Warranty repairs must be carried out by a 'The Fire Dept.' authorised technician.

This appliance must ALWAYS terminate/flue outdoors.

Young children, elderly or infirm should be supervised to ensure that they are careful with the appliance.

Clothing and other flammable materials should never be placed near the appliance.

Please note that parts (near the flame) of this appliance become extremely hot during operation and can result in serious injury and burns if touched. It is therefore recommended that a fireguard complying with BS 8423:2002 is used in the presence of young children, the elderly or infirm.

This installation guide must be read in conjunction with the technical specifications for this appliance. If an optional log ignitor is being used, it must be installed in accordance with the relevant log ignitor installation guide.

The WD1 (concrete and timber cavity) installation process consists of 8 steps

	Page
Step 1: Ensure all components are correct and undamaged	3
Step 2: Pre-installation checklist	4
Step 3: Fit gather	5
Step 4: Fit flue	6
Step 5: Fit internal front and rear panels inside gather	7
Step 6: Install fire bricks	8
Step 7: Place grate into fire brick cavity	9
Step 8: Show owner how to operate appliance	10
Operating Instructions	11
Troubleshooting	11
Warranty	12

Information in this installation guide may be subject to change without notice.

Please ensure you have the current version before beginning installation.

If you have any queries, please contact 'The Fire Dept.' on 0800 888 550

Step 1: Unpack and ensure all components are correct and undamaged

- Gather.
- Internal front and rear panels.
- Grate.
- Cavity closer panel.
- Flue kit.
- Fire bricks.
- Log ignitor (optional).
- WD1 Open Front and Right technical specification (to be read in conjunction with this installation guide)
- Appropriate log ignitor installation guide, if optional log ignitor is being used.

Step 2: Pre-installation checklist

- Ensure cavity dimensions are correct – refer to technical specification.
- Ensure hearth dimensions are correct – refer to technical specifications.
- Plan flue path.
- If optional log ignitor is to be installed, check how gas and electricity supplies run to log ignitor.

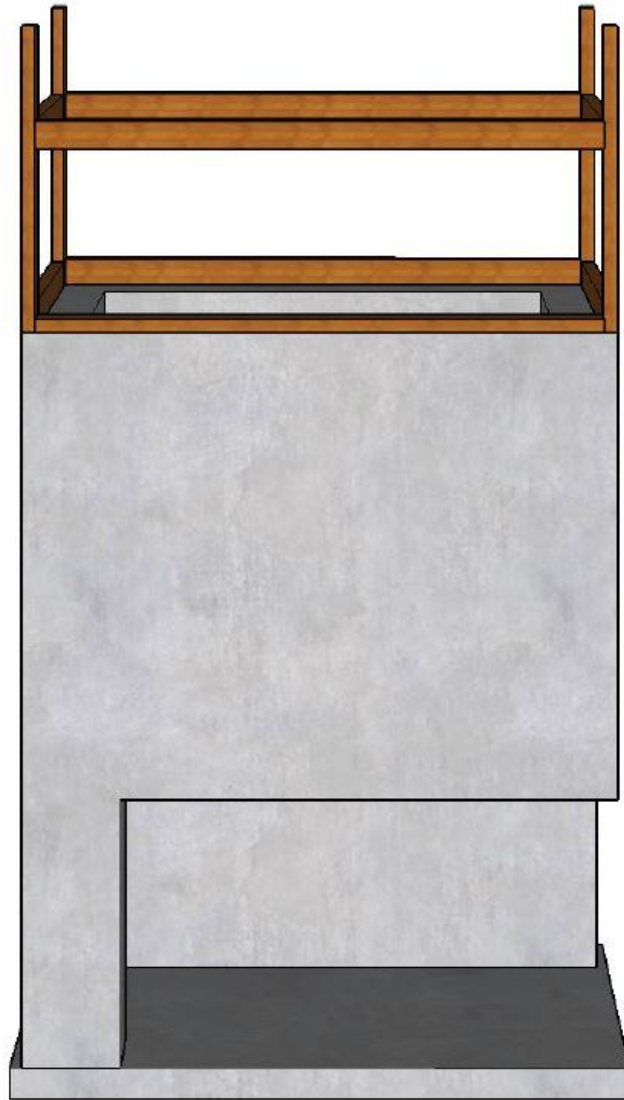

The starting point: Concrete and timber cavity.

Step 3: Fit gather

- 7 components, plus fasteners.

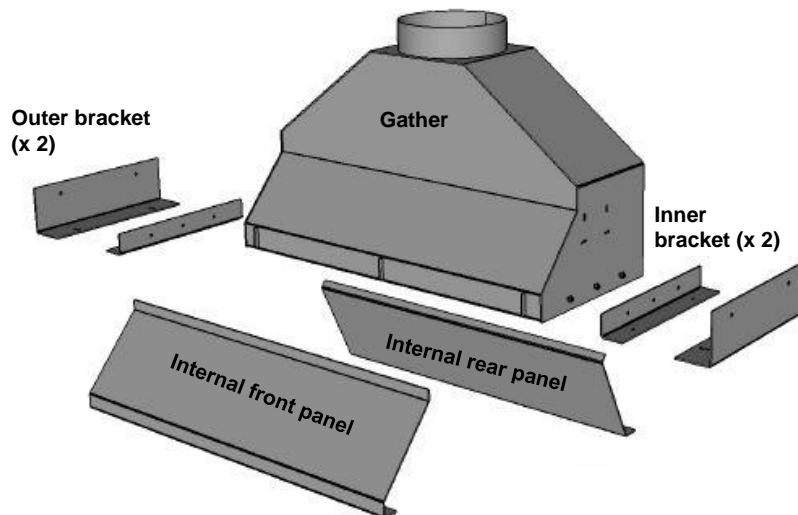

1. Remove inner and outer brackets and internal front and rear panels.

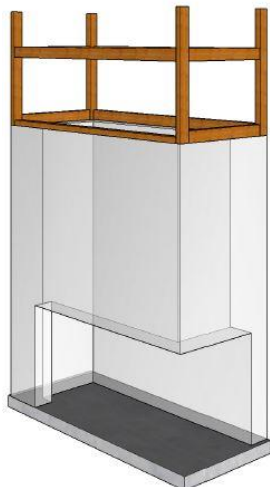

2. Double-check chimney cavity dimensions are correct.

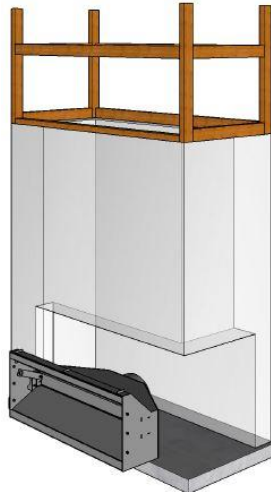

3. Lay the gather on its back in front of the cavity opening.

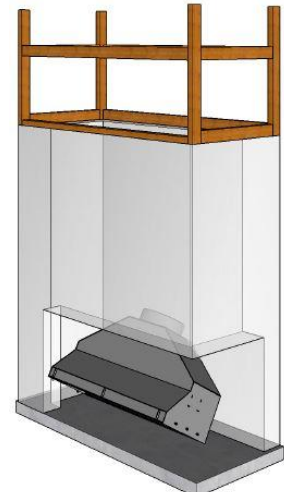

4. Slide the gather into the cavity opening and connect the block and tackle through the flue spigot.

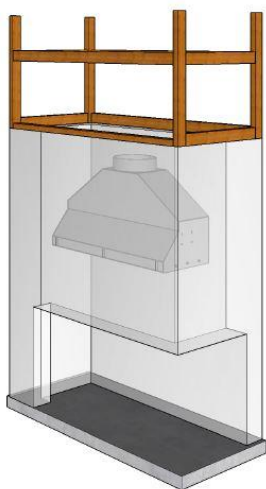

5. Lift the gather into the cavity, allowing it to tilt into an upright position

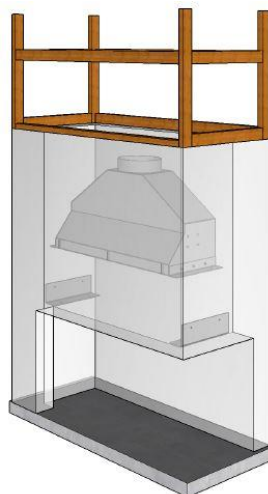

6. Bolt the inner brackets to the gather (3 x 10mm bolts at each side). Drill and bolt the outer brackets to each side of the cavity (2 x 10mm concrete fixing bolts at each side). Check technical specifications for outer bracket height and positions.

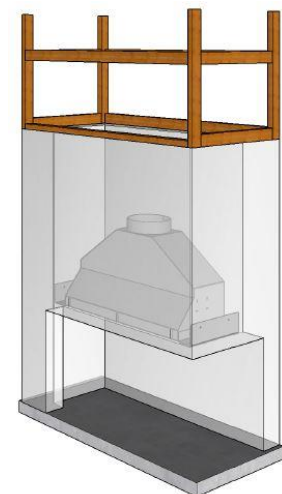

7. Lower the gather into position and bolt it onto the outer brackets. 2 x 10mm bolts at each side (into slots which allow adjustment).

Step 4: Fit flue

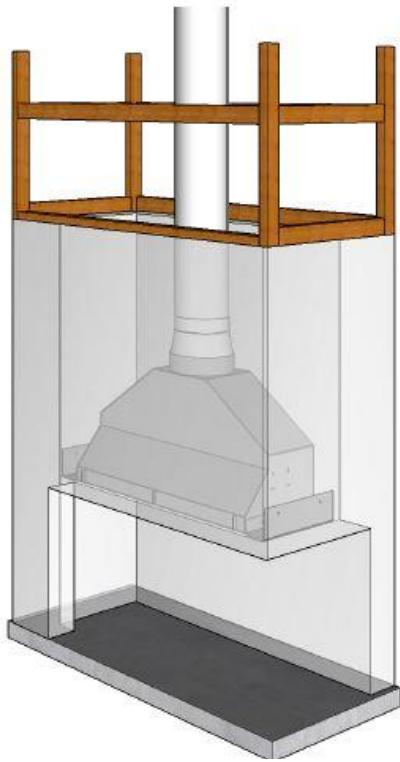

1. Run the first section of flue and flue reducer onto gather.

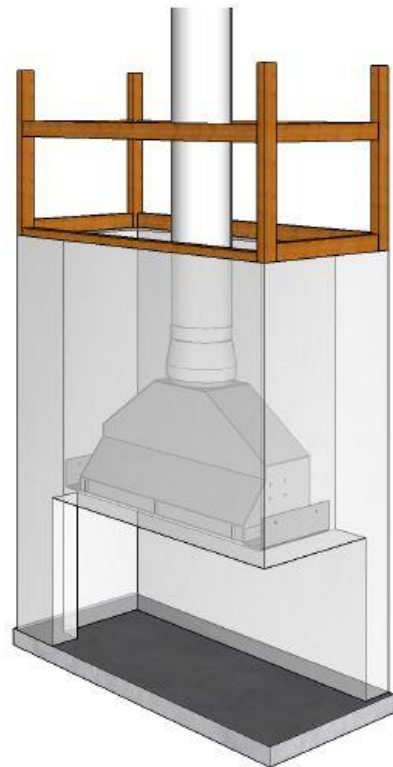

2. Run the first section of inner casing and casing reducer onto gather. Ensure 25mm gap between casing reducer and gather.

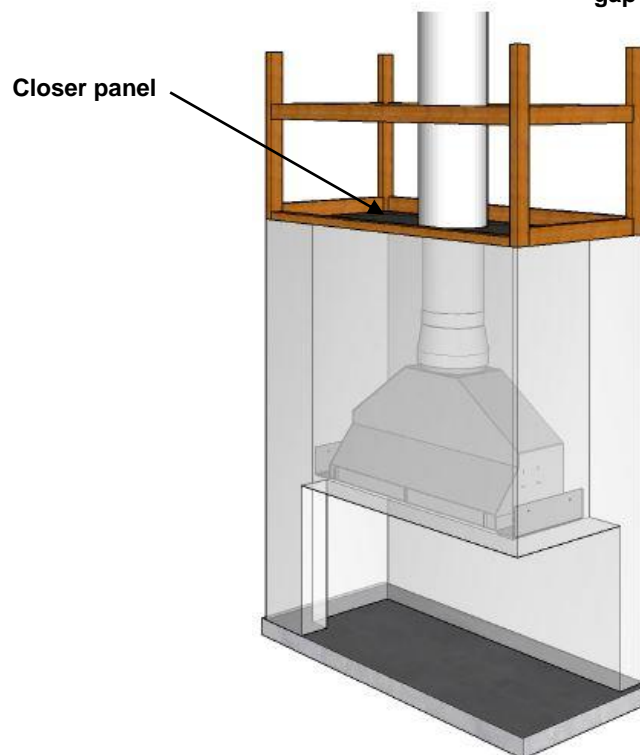

3. Fix the closer panel into position on top of the concrete chimney cavity. Then run the first section of the outer casing onto the closer panel.

4. Complete the rest of the flue installation.

Step 5: Fit internal front and rear panels inside gather

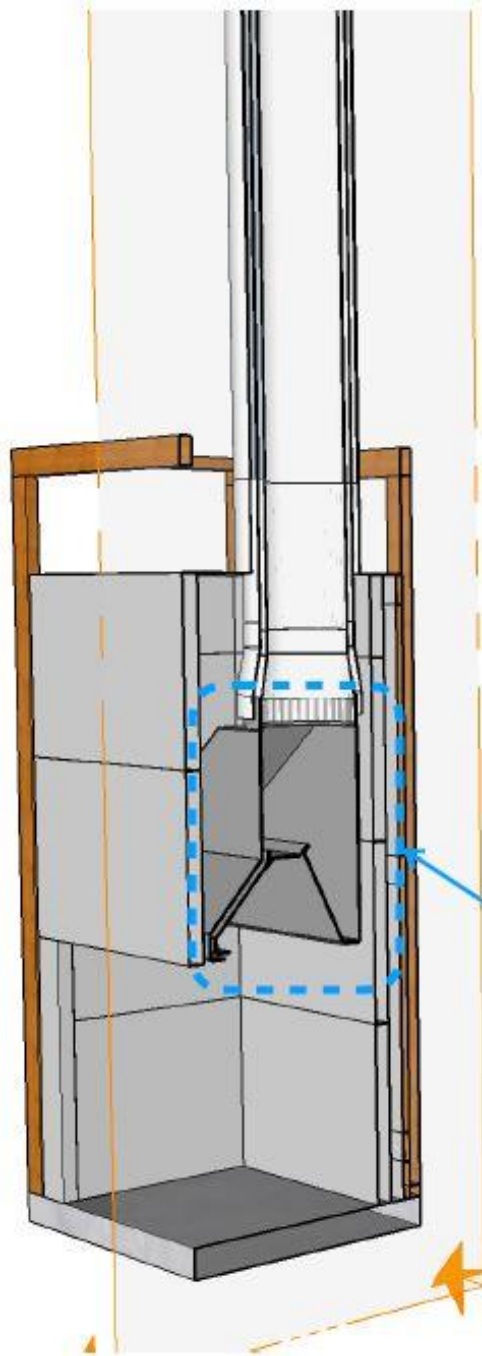

Internal panels in place- cutaway view.

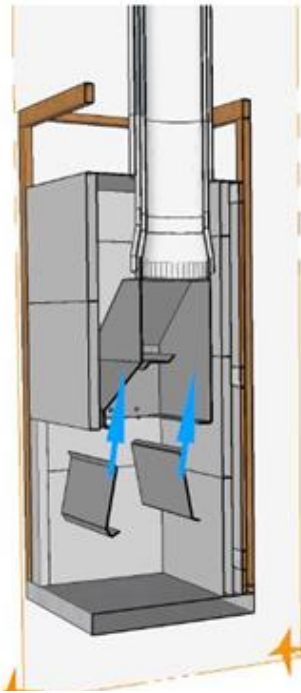

Using two people, lift internal panels into place. Watch your fingers!

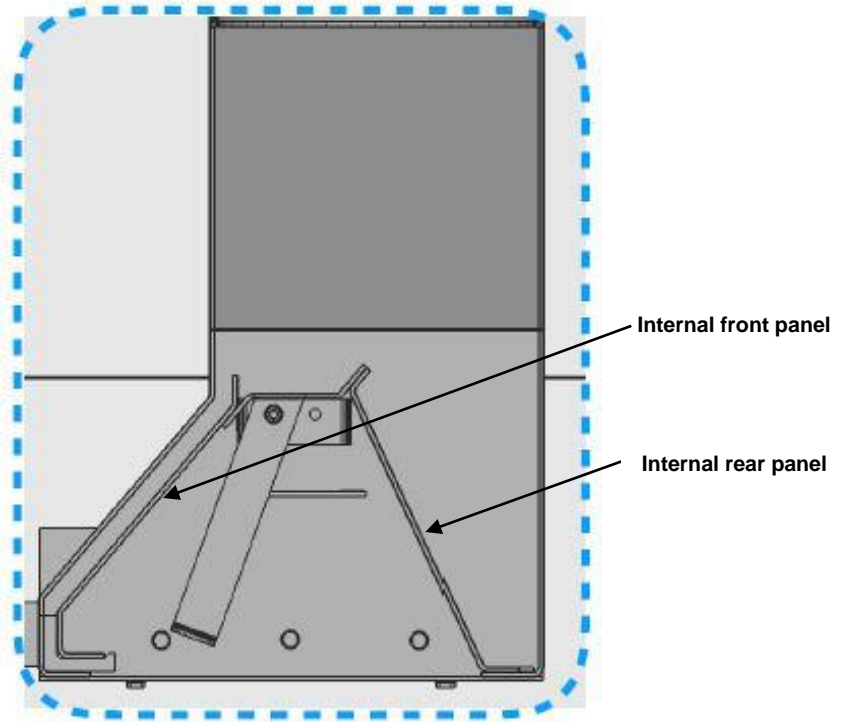

Internal panels in place- side view.

Step 6: Install fire bricks

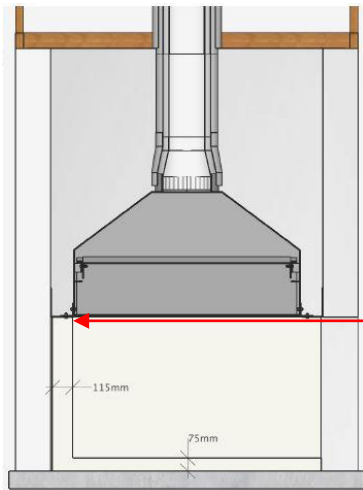

IMPORTANT: To avoid smoke entering the cavity, ensure the fire bricks are flush with the gather internal back panel and side. Fill gap between fire bricks and underside of gather with refractory cement.

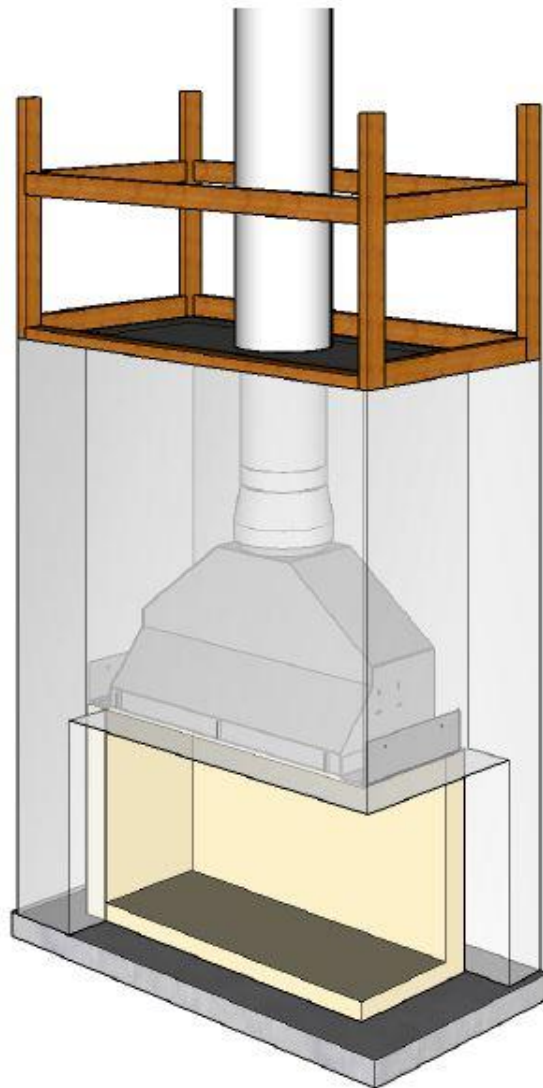
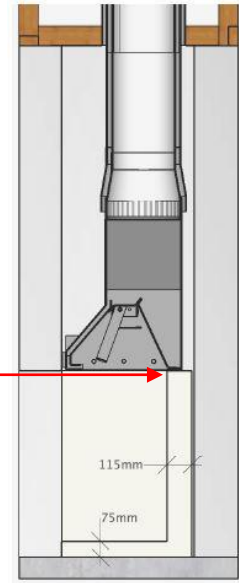

Fire bricks complete.

Step 7: Place grate into fire brick cavity

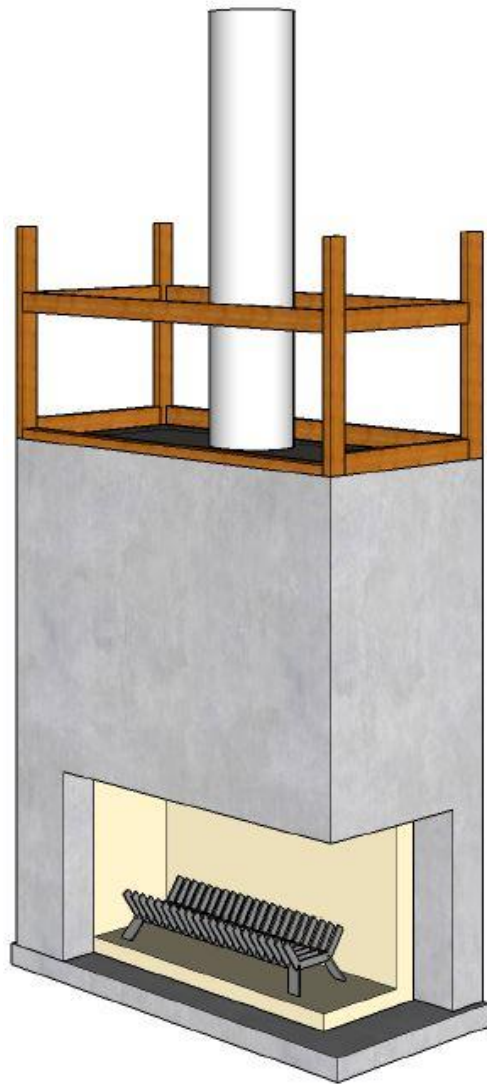

Place the grate 150mm in from fire brick side wall.

Appliance is now ready for customer-specified outer finishes.

Step 8: Show owner how to operate appliance

- Following the Operating Instructions on the next page, show the owner how to operate the flue damper, and if fitted, the log ignitor.
- If the owner is not available, leave this manual by the appliance.

OPERATING INSTRUCTIONS

- The WD1 has an integrated flue damper which has two positions – open and closed.
- The flue damper **MUST** be in the open position when the fire is being used. To set the flue damper to the open position, simply push it to the rear of the fire.
- If the fire is not being used for an extended period (for example, over summer), the flue damper can be pulled forward to the closed position, which reduces external noises and drafts.

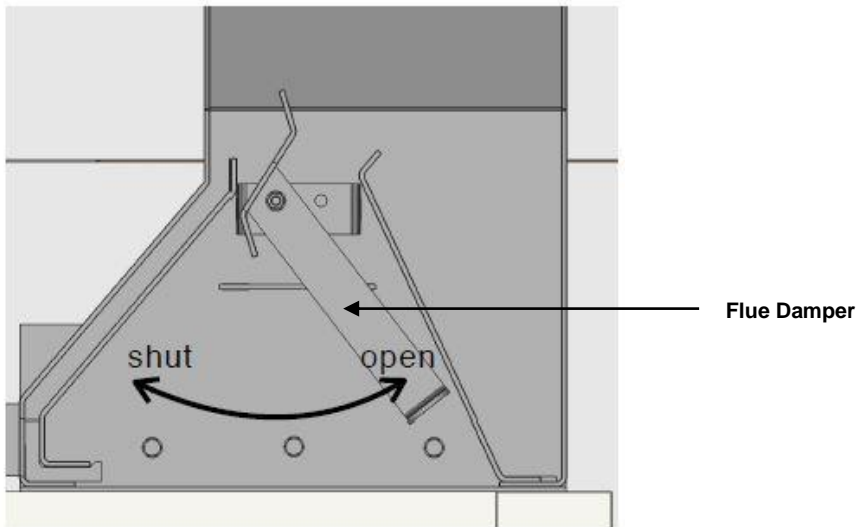

- **Ongoing maintenance.** It is recommended that the flue be swept every year (some insurance companies require this), or more often if required. Fire bricks will deteriorate over time and must be regularly checked for cracking and movement. Repair or replace as required.

.....

TROUBLESHOOTING

Problem	Probable Cause	Action
Smoke is entering room	<ol style="list-style-type: none"> 1. Poor quality or damp wood 2. Flue damper is closed 3. Draft flowing into or across fire 4. Flue terminates at poor position outside (eg. windy part of roof) 5. A nearby extractor fan is sucking smoke from the fire 	<ol style="list-style-type: none"> 1. Change wood 2. Open flue damper 3. Remove source of draft 4. Reposition flue termination 5. Switch off or reposition extractor fan
Flue damper doesn't stay in open position	Flue dumper bolts have loosened	Tighten flue dumper bolts and locknuts – one on each side

PRODUCT WARRANTY

IMPORTANT: Evidence of original purchase is required for warranty service.

WARRANTOR: 'The Fire Dept.' (Landscape Elements Ltd)
85 Newton Road
Mount Maunganui
PO Box 10275, Bayfair, Mount Maunganui

ELEMENT OF WARRANTY

'The Fire Dept.' warrants to the original retail owner for the duration of this warranty, it's fireboxes, gas burner tray, lighters, (herein after referred to as the Product) to be free from defects in materials and craftsmanship with only the limitations or exclusions set out below.

WARRANTY

This warranty will be deemed invalid if the Product is;

- (A) Installed by someone other than an authorised Fire Dept agent.
- (B) Not operated appropriately or "over-fired" in a manner resulting in the firebox operating excessively hot.
- (C) Not serviced and maintained by a certified gas fitter every 12 months.
- (D) Damaged by accident, neglect or misuse,
- (E) Repaired by someone other than an authorised Fire Dept repair agent for a defect or malfunction covered by this warranty.
- (F) Modified, altered or used as part of any conversion kits, subassemblies, or any configurations not sold by 'The Fire Dept.'
- (G) The product contains fire bricks and has not been subjected to the recommended first start-up and run-in procedure.
- (H) Used in conjunction with any equipment or parts or as part of a system not manufactured or supplied by 'The Fire Dept.'
- (I) External powder-coating within 200m of the high tide mark and not lightly washed with warm soapy water every three months.

Indoor appliances (Gas & Wood)

'The Fire Dept.'. warrants the mild steel firebox, galvanised steel outer skin and RHS Duragal steel support frame against defective materials and workmanship which would render it unfit for normal domestic use, from the date of purchase by the original consumer, for a period of 5 (five) years. Beyond normal heat-induced staining, tarnishing and mild warping, if a firebox, outer skin or support frame defect occurs, contact 'The Fire Dept.' and the defect will be repaired or replaced at our discretion with all costs covered.

'The Fire Dept.' warrants the SIT Pack (Gas regulator and controller) against defective materials and workmanship which would render it unfit for normal domestic use, from the date of purchase by the original consumer, for a period of 2 (two) years.

Components including fire medium, fans, tiles, glass and glass trim are warranted for a period of 2 (two) years from the date of original purchase, against defective materials and workmanship.

Outdoor appliances (Gas & Wood)

'The Fire Dept.' warrants the Mild Steel firebox, galvanised steel outer skin and RHS Duragal Steel support frame against defective materials and workmanship which would render it unfit for normal domestic use, from the date of purchase by the original consumer, for a period of 2 (two) years. Beyond normal heat-induced staining, tarnishing and mild warping, if a firebox, outer skin or support frame defect occurs, contact 'The Fire Dept.' and the defect will be repaired or replaced at our discretion with all costs covered.

'The Fire Dept.' warrants the SIT Pack (Gas regulator and controller) against defective materials and workmanship which would render it unfit for normal domestic use, from the date of purchase by the original consumer, for a period of 2 (two) years.

Components including fire medium, fans, tiles, glass and glass trim are warranted for a period of 2 (two) years from the date of original purchase for domestic use, against defective materials and workmanship.

STATEMENT OF REMEDY

In the event that the Product does not conform to this warranty at any time while this warranty is in effect, the Warrantor, at its discretion, will repair the defect or replace the part and return it to you without charge for parts or service. This warranty does not provide for reimbursement or payment of incidental or consequential damages.

This warranty does not in any way affect your rights under the Consumers Guarantee Act (New Zealand).