

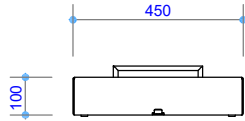

**GD10 | 2000
SPECIFICATIONS**

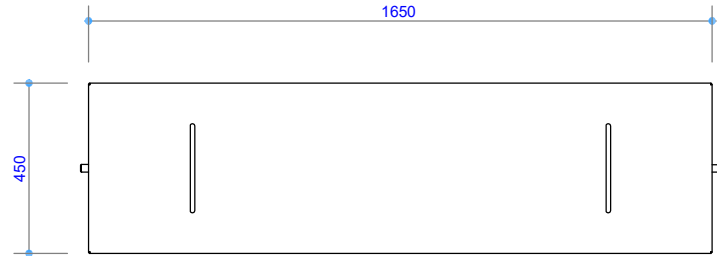

Side view - Cover



Plan view - Cover

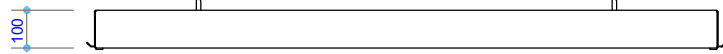

Front view - Cover

NOTE:
Gas and power supply
from below. Location
within marked area.

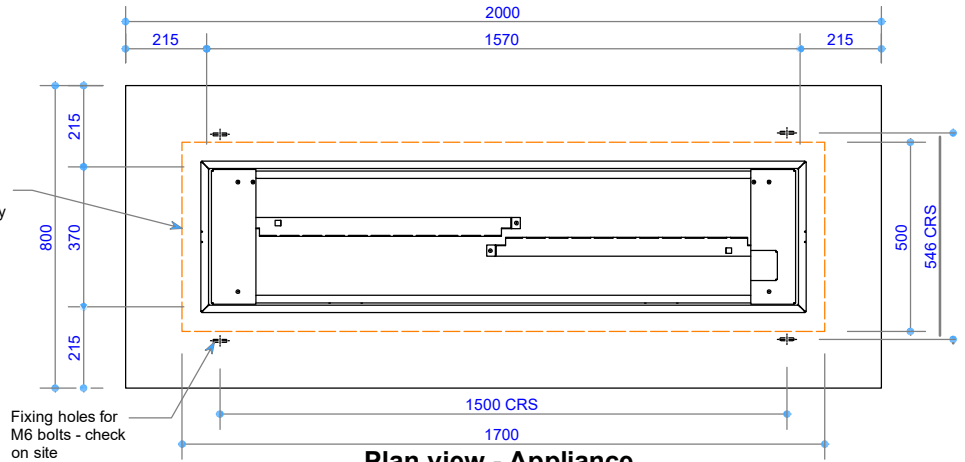

Plan view - Appliance

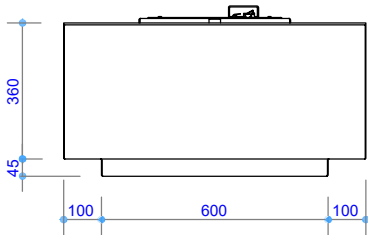

Side view

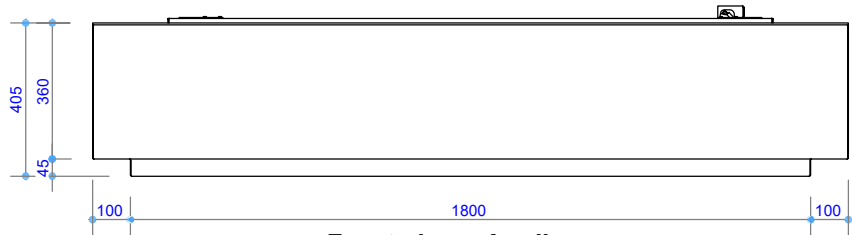

Front view - Appliance

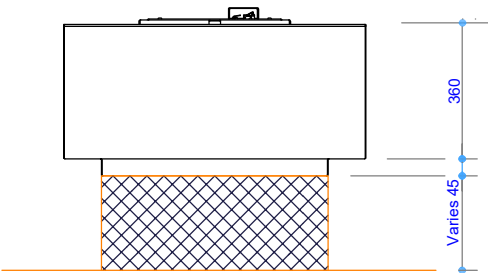

NOTE:
Structure to support appliance.
Design for 200kg load.

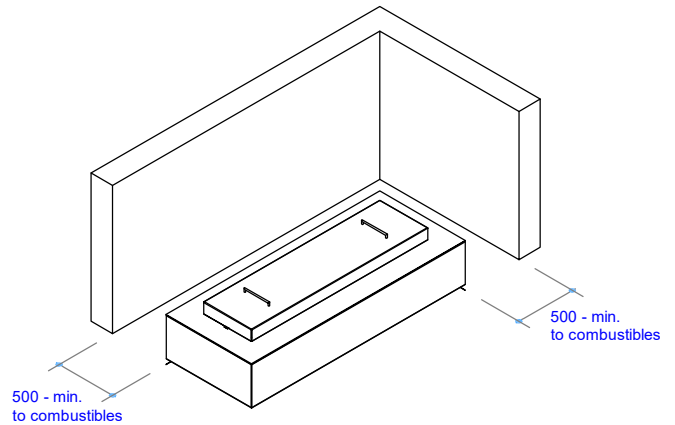

Appliance installation - Trim sizes

NOTE: Confirm fixing holes on site prior to drilling

COPYRIGHT ©
 THIS DRAWING IS THE PROPERTY
 OF The Fire Dept.

Client: THE FIRE DEPT.

Product: GD10-2000

Title: VERTICAL FLUE COMBINATION OPTIONS

Drawn: LB

Date: 20/05/2020

Chkd: JW

Date: 08/05/2018

Appd: JW

Date: 08/05/2018

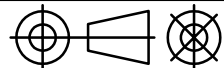

Scale: on A4

THE
 FIRE
 DEPT.
 HAND CRAFTED FIRES

Drawing No. **GD10-2000-901**

Sheet 01 of 02

Revision 3

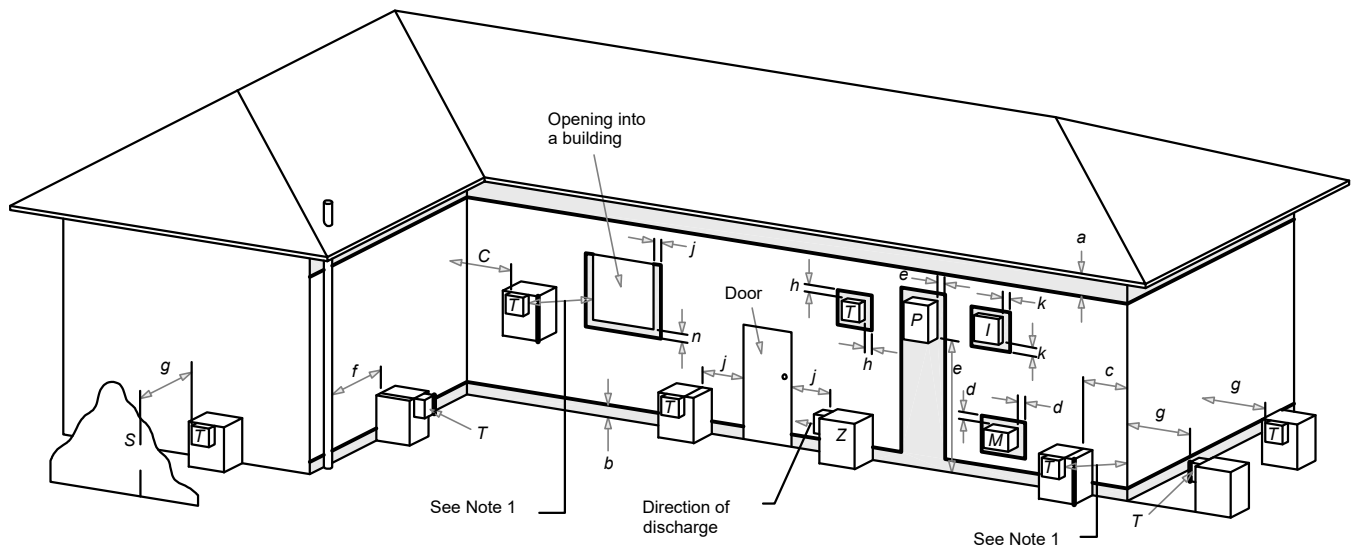

LEGEND:
 I = Mechanical air inlet
 M = Gas meter
 P = Electricity meter or fuse box
 S = Structure
 T = Flue terminal
 Z = Fan-assisted appliance only

a = 200 g = 500
 b = 300 h = 300
 c = 300 j = 300 (at window) & 1500
 d = 1000 (fan-assisted appliance by the door)
 e = 500 k = 1000
 f = 75 n = 500

NOTES:
 1 Where dimensions c, j or k cannot be achieved an equivalent horizontal distance measured diagonally from the nearest discharge point of the terminal to the opening may be deemed by the Technical Regulator to comply.

 Shading indicates prohibited area for flue terminals

Location of Flue Terminals of Balanced Flue, Room-Sealed, Fan-Assisted or Outdoor Appliances

NOTE: To be read in conjunction with AS/NZS 5601.1:2013

COPYRIGHT ©
 THIS DRAWING IS THE PROPERTY
 OF The Fire Dept.

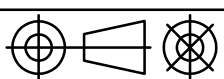
Client: THE FIRE DEPT.		
Product: GD10-2000		
Title: FLUE EXIT CLEARANCES		
Drawn: LB	Date: 20/05/2020	
Chkd: JW	Date: 08/05/2018	
Appd: JW	Date: 08/05/2018	
Scale:		on A4

THE
 FIRE
 DEPT.
 HAND CRAFTED FIRES

Drawing No.	GD10-2000-902	Sheet 02 of 02	Revision 3
-------------	---------------	----------------	--